



***A7N8X-E***  
***Deluxe***

User Guide

**Motherboard**

**E1465**

**Revised Edition V2**

**October 2003**

**Copyright © 2003 ASUSTeK COMPUTER INC. All Rights Reserved.**

No part of this manual, including the products and software described in it, may be reproduced, transmitted, transcribed, stored in a retrieval system, or translated into any language in any form or by any means, except documentation kept by the purchaser for backup purposes, without the express written permission of ASUSTeK COMPUTER INC. ("ASUS").

Product warranty or service will not be extended if: (1) the product is repaired, modified or altered, unless such repair, modification or alteration is authorized in writing by ASUS; or (2) the serial number of the product is defaced or missing.

ASUS PROVIDES THIS MANUAL "AS IS" WITHOUT WARRANTY OF ANY KIND, EITHER EXPRESS OR IMPLIED, INCLUDING BUT NOT LIMITED TO THE IMPLIED WARRANTIES OR CONDITIONS OF MERCHANTABILITY OR FITNESS FOR A PARTICULAR PURPOSE. IN NO EVENT SHALL ASUS, ITS DIRECTORS, OFFICERS, EMPLOYEES OR AGENTS BE LIABLE FOR ANY INDIRECT, SPECIAL, INCIDENTAL, OR CONSEQUENTIAL DAMAGES (INCLUDING DAMAGES FOR LOSS OF PROFITS, LOSS OF BUSINESS, LOSS OF USE OR DATA, INTERRUPTION OF BUSINESS AND THE LIKE), EVEN IF ASUS HAS BEEN ADVISED OF THE POSSIBILITY OF SUCH DAMAGES ARISING FROM ANY DEFECT OR ERROR IN THIS MANUAL OR PRODUCT.

SPECIFICATIONS AND INFORMATION CONTAINED IN THIS MANUAL ARE FURNISHED FOR INFORMATIONAL USE ONLY, AND ARE SUBJECT TO CHANGE AT ANY TIME WITHOUT NOTICE, AND SHOULD NOT BE CONSTRUED AS A COMMITMENT BY ASUS. ASUS ASSUMES NO RESPONSIBILITY OR LIABILITY FOR ANY ERRORS OR INACCURACIES THAT MAY APPEAR IN THIS MANUAL, INCLUDING THE PRODUCTS AND SOFTWARE DESCRIBED IN IT.

Products and corporate names appearing in this manual may or may not be registered trademarks or copyrights of their respective companies, and are used only for identification or explanation and to the owners' benefit, without intent to infringe.

# Contents

Notices .....	vi
Safety information .....	vii
About this guide .....	viii
How this guide is organized .....	viii
Conventions used in this guide .....	ix
Where to find more information .....	ix
A7N8X-E Deluxe specifications summary .....	x

## Chapter 1: Product introduction

1.1 Welcome! .....	1-1
1.2 Package contents .....	1-1
1.3 Special features .....	1-2
1.3.1 Product Highlights .....	1-2
1.3.2 Unique ASUS features .....	1-3

## Chapter 2: Hardware information

2.1 Before you proceed .....	2-1
2.2 Motherboard overview .....	2-2
2.2.1 Placement direction .....	2-2
2.2.2 Screw holes .....	2-2
2.2.3 Motherboard layout .....	2-3
2.2.4 Layout Contents .....	2-4
2.3 Central Processing Unit (CPU) .....	2-6
2.3.1 Overview .....	2-6
2.3.2 Installing the CPU .....	2-6
2.4 System memory .....	2-8
2.4.1 Overview .....	2-8
2.4.2 Memory configurations .....	2-8
2.4.3 Installing a DIMM .....	2-10
2.4.4 Removing a DIMM .....	2-10
2.5 Expansion slots .....	2-11
2.5.1 Installing an expansion card .....	2-11
2.5.2 Configuring an expansion card .....	2-11
2.5.3 Interrupt assignments .....	2-12
2.5.4 PCI slots .....	2-13
2.5.5 AGP slot .....	2-13
2.5.6 Wi-Fi slot .....	2-14

# Contents

2.6	Jumpers .....	2-15
2.7	Connectors .....	2-18
2.7.1	Rear panel connectors .....	2-18
2.7.2	Internal connectors .....	2-19

## Chapter 3: Powering up

3.1	Starting up for the first time .....	3-1
3.2	Powering off the computer .....	3-2
3.2.1	Using the OS shut down function .....	3-2
3.2.2	Using the dual function power switch .....	3-2
3.3	ASUS POST Reporter™ .....	3-3
3.3.1	Vocal POST messages .....	3-3
3.3.2	Winbond Voice Editor .....	3-5

## Chapter 4: BIOS setup

4.1	Managing and updating your BIOS .....	4-1
4.1.1	Creating a bootable floppy disk .....	4-1
4.1.2	AwardBIOS Flash Utility .....	4-2
4.1.3	ASUS Update .....	4-5
4.2	BIOS Setup program .....	4-7
4.2.1	BIOS menu screen .....	4-8
4.2.2	Menu bar .....	4-8
4.2.3	Navigation keys .....	4-8
4.2.4	Menu items .....	4-9
4.2.5	Sub-menu items .....	4-9
4.2.6	Configuration fields .....	4-9
4.2.7	General help .....	4-9
4.2.8	Pop-up window .....	4-9
4.2.9	Scroll bar .....	4-9
4.3	Main menu .....	4-10
4.3.1	System Time [xx:xx:xxxx] .....	4-10
4.3.2	System Date [Day xx/xx/xxxx] .....	4-10
4.3.3	Legacy Diskette A [1.44M, 3.5 in.] .....	4-10
4.3.4	Halt On [All Errors] .....	4-10
4.3.5	Primary and Secondary Master/Slave .....	4-11
4.4	Advanced menu .....	4-14
4.4.1	Advanced BIOS Features .....	4-15
4.4.2	Advanced Chipset Features .....	4-18
4.4.3	Integrated Peripherals .....	4-22

# Contents

4.4.4	Power Management Setup .....	4-24
4.4.5	PnP/PCI Configurations .....	4-26
4.5	Security Menu .....	4-27
4.6	Hardware Monitor Menu .....	4-29
4.7	Exit Menu .....	4-30

## Chapter 5: Software support

5.1	Install an operating system .....	5-1
5.2	Support CD information .....	5-1
5.2.1	Running the support CD .....	5-1
5.2.2	Drivers menu .....	5-2
5.2.3	Utilities menu .....	5-3
5.2.4	ASUS Contact Information .....	5-4
5.2.5	Other information .....	5-5
5.3	NVIDIA® nForce control panel .....	5-7
5.3.1	Launching the NVIDIA® control panel .....	5-7
5.3.2	Main .....	5-7
5.3.3	Speaker Setup .....	5-7
5.3.4	MIDI .....	5-9
5.3.5	Environment .....	5-9
5.3.6	Applications .....	5-9
5.3.7	Information .....	5-10
5.4	NVIDIA® NVSwap 1.0 Utility .....	5-11
5.5	RAID 0/RAID 1 Configurations .....	5-13
5.5.1	Install the hard disks .....	5-13
5.5.2	Creating and Deleting RAID sets .....	5-14
5.6	Onboard Marvell Gigabit LAN drivers for Windows 98SE/ME .....	5-16
5.7	Marvell® Virtual Cable Tester™ (VCT) Technology .....	5-17

## Quick Reference Card

# Notices

## Federal Communications Commission Statement

This device complies with Part 15 of the FCC Rules. Operation is subject to the following two conditions:

- This device may not cause harmful interference, and
- This device must accept any interference received including interference that may cause undesired operation.

This equipment has been tested and found to comply with the limits for a Class B digital device, pursuant to Part 15 of the FCC Rules. These limits are designed to provide reasonable protection against harmful interference in a residential installation. This equipment generates, uses and can radiate radio frequency energy and, if not installed and used in accordance with manufacturer's instructions, may cause harmful interference to radio communications. However, there is no guarantee that interference will not occur in a particular installation. If this equipment does cause harmful interference to radio or television reception, which can be determined by turning the equipment off and on, the user is encouraged to try to correct the interference by one or more of the following measures:

- Reorient or relocate the receiving antenna.
- Increase the separation between the equipment and receiver.
- Connect the equipment to an outlet on a circuit different from that to which the receiver is connected.
- Consult the dealer or an experienced radio/TV technician for help.



---

The use of shielded cables for connection of the monitor to the graphics card is required to assure compliance with FCC regulations. Changes or modifications to this unit not expressly approved by the party responsible for compliance could void the user's authority to operate this equipment.

---

## Canadian Department of Communications Statement

This digital apparatus does not exceed the Class B limits for radio noise emissions from digital apparatus set out in the Radio Interference Regulations of the Canadian Department of Communications.

**This class B digital apparatus complies with Canadian ICES-003.**

# Safety information

## Electrical safety

- To prevent electrical shock hazard, disconnect the power cable from the electrical outlet before relocating the system.
- When adding or removing devices to or from the system, ensure that the power cables for the devices are unplugged before the signal cables are connected. If possible, disconnect all power cables from the existing system before you add a device.
- Before connecting or removing signal cables from the motherboard, ensure that all power cables are unplugged.
- Seek professional assistance before using an adapter or extension cord. These devices could interrupt the grounding circuit.
- Make sure that your power supply is set to the correct voltage in your area. If you are not sure about the voltage of the electrical outlet you are using, contact your local power company.
- If the power supply is broken, do not try to fix it by yourself. Contact a qualified service technician or your retailer.

## Operation safety

- Before installing the motherboard and adding devices on it, carefully read all the manuals that came with the package.
- Before using the product, make sure all cables are correctly connected and the power cables are not damaged. If you detect any damage, contact your dealer immediately.
- To avoid short circuits, keep paper clips, screws, and staples away from connectors, slots, sockets and circuitry.
- Avoid dust, humidity, and temperature extremes. Do not place the product in any area where it may become wet.
- Place the product on a stable surface.
- If you encounter technical problems with the product, contact a qualified service technician or your retailer.

# About this guide

This user guide contains the information you need when installing and configuring the motherboard.

## How this guide is organized

This manual contains the following parts:

- **Chapter 1: Product introduction**  
This chapter describes the motherboard features of the and the new technologies it supports.
- **Chapter 2: Hardware information**  
This chapter lists the hardware setup procedures that you have to perform when installing system components. It includes description of the jumpers and connectors on the motherboard.
- **Chapter 3: Powering up**  
This chapter describes the power up sequence, the vocal POST messages, and ways of shutting down the system.
- **Chapter 4: BIOS setup**  
This chapter tells how to change system settings through the BIOS Setup menus. Detailed descriptions of the BIOS parameters are also provided.
- **Chapter 5: Software support**  
This chapter describes the contents of the support CD that comes with the motherboard package.



## Conventions used in this guide

To make sure that you perform certain tasks properly, take note of the following symbols used throughout this manual.



**DANGER/WARNING:** Information to prevent injury to yourself when trying to complete a task.



**CAUTION:** Information to prevent damage to the components when trying to complete a task.



**IMPORTANT:** Information that you **MUST** follow to complete a task.



**NOTE:** Tips and additional information to aid in completing a task.

## Where to find more information

Refer to the following sources for additional information and for product and software updates.

### 1. ASUS websites

The ASUS websites worldwide provide updated information on ASUS hardware and software products. Refer to the ASUS contact information.

### 2. Optional documentation

Your product package may include optional documentation, such as warranty flyers, that may have been added by your dealer. These documents are not part of the standard package.

## A7N8X-E Deluxe specifications summary

<b>CPU</b>	Socket A for AMD Duron™/AMD Athlon™/AMD Athlon™ XP 3200+ processors
<b>Front Side Bus (FSB)</b>	400/333/266/200Mhz
<b>Chipset</b>	Northbridge: NVIDIA® nForce2 Ultra 400 Southbridge: NVIDIA® nForce2 MCP-T
<b>Memory</b>	Dual-channel memory architecture 3 x 184-pin DDR DIMM sockets for up to 3GB memory Supports PC3200/PC2700/PC2100/PC1600 unbuffered non-ECC DDR DIMMs
<b>Expansion slots</b>	5 x PCI 1 x AGP Pro/8X (1.5V only) 1 x ASUS proprietary Wi-Fi slot
<b>Storage</b>	2 x UltraDMA 133/100/66/33 2 x Serial ATA with RAID 0, 1 support
<b>Audio</b>	MCP-T southbridge integrated Audio Processor Unit (APU) + Realtek ALC650 6-channel audio CODEC
<b>LAN</b>	Marvell® 88E8001 Gigabit LAN MCP-T southbridge integrated controller MAC + Realtek 8201BL LAN PHY
<b>1394</b>	MCP-T southbridge integrated IEEE1394a controller + Realtek 8801B PHY
<b>Special Features</b>	ASUS Q-Fan Technology ASUS POST Reporter ASUS C.O.P. (CPU Overheating Protection) Power Loss Restart CPU Throttle
<b>Rear Panel I/O</b>	1 x parallel port 1 x serial port 1 x PS/2 keyboard port 1 x PS/2 mouse port 1 x S/PDIF in/out port 1 x surround L/R audio jack 1 x CNTR/LFE audio jack 1 x audio I/O port 1 x Gigabit RJ-45 Port 1 x Fast Ethernet RJ-45 port 4 x USB 2.0 ports

*(continued on the next page)*

# A7N8X-E Deluxe specifications summary

<b>Internal I/O Connectors</b>	USB 2.0 connector supports additional 2 USB 2.0 ports Game/MIDI connector CPU/Power/Chassis fan connectors 2 x IDE connectors 20-pin ATX power connector 2 x SATA connectors 2 x 1394 connectors Chassis intrusion connector Infrared module connector CD / AUX / Modem connector Front panel audio connector Serial port 2 connector S/PDIF connector
<b>BIOS features</b>	4Mb Flash ROM, Award BIOS, PnP, DMI2.0, Green
<b>Industry standard</b>	PCI 2.2, USB 1.1/2.0.
<b>Manageability</b>	DMI 2.0, WOL, WOR, Chassis Intrusion
<b>Form Factor</b>	ATX form factor: 12 in x 9.6 in (30.5 cm x 24.5 cm)
<b>Support CD contents</b>	Device drivers ASUS PC Probe I'm InTouch™ Remote Access Application Trend Micro™ PC-cillin 2002 anti-virus software ASUS LiveUpdate Utility

\* Specifications are subject to change without notice.



# ***Chapter 1***

This chapter describes the motherboard features and the new technologies it supports.

## **Product introduction**

## **Chapter summary**

<b>1.1</b>	<b>Welcome! .....</b>	<b>1-1</b>
<b>1.2</b>	<b>Package contents .....</b>	<b>1-1</b>
<b>1.3</b>	<b>Special features .....</b>	<b>1-2</b>

# 1.1 Welcome!

**Thank you for buying the ASUS® A7N8X-E Deluxe motherboard!**

The motherboard delivers a host of new features and latest technologies making it another standout in the long line of ASUS quality motherboards!

The motherboard supports the AMD Athlon™, AMD Athlon™ XP or AMD Duron™ processors in a Socket A (462-pin) package with the NVIDIA® nForce2™ Ultra 400 chipset to set a new benchmark for an effective desktop platform solution.

Supporting up to 3GB of system memory with PC3200/PC2700/PC2100/PC1600 DDR SDRAM, high-resolution graphics via an AGP 8X slot, SATA, RAID, IEEE 1394, USB 2.0, and 6-channel audio features, the motherboard takes you ahead in the world of power computing!

Before you start installing the motherboard, and hardware devices on it, check the items in your package with the list below.

## 1.2 Package contents

Check your motherboard package for the following items.

- ✓ ASUS motherboard
- ✓ ASUS support CD
- ✓ 2 x SATA cables
- ✓ 1 x SATA power cable
- ✓ 1 x 2-port USB module w/ cable
- ✓ 1 x 2-port IEEE1394 module
- ✓ 1 x 80-conductor ribbon cable for UltraDMA/66/100/133 IDE drives
- ✓ 1 x 40-conductor IDE cable
- ✓ 1 x Ribbon cable for a 3.5-inch floppy drive
- ✓ WinDVD Suite
- ✓ I/O shield
- ✓ Bag of extra jumper caps
- ✓ User Guide (includes Quick Reference Card)
- ✓ Quick Setup Guide
- ✓ Jumper/Connector sticker



---

If any of the above items is damaged or missing, contact your retailer.

---

## 1.3 Special features

### 1.3.1 Product Highlights

#### Latest processor technology

The motherboard supports the latest AMD Athlon™, Athlon™ XP and AMD Duron™ processors via a 462-pin surface mount ZIF socket. The AMD Athlon™ and AMD Athlon™ XP processors features a 400Mhz front side bus and the QuantiSpeed™ architecture for rapid execution of applications.

#### NVIDIA® nForce™ Platform Processing Architecture

The motherboard combines the power of NVIDIA's nForce2™ Ultra 400 and nForce2™ MCP-T chipsets that improves processing efficiency and overall system performance.

#### Serial ATA solution



The motherboard supports two interfaces compliant to the Serial ATA (SATA) specification, an evolutionary replacement of the Parallel ATA storage interface. The Serial ATA specification allows for thinner, more flexible cables with lower pin count, reduced voltage requirement, up to 150 MB/s data transfer rate. See page 2-21.

#### AGP 8X support

The motherboard support AGP 8X (AGP 3.0) specification offering 2.12 GB/s bandwidth. See page 2-13.

#### Dual LAN (Fast-Ethernet and Gigabit) solution

The onboard Marvell® Gigabit LAN controller and Fast-Ethernet LAN controller integrated in the southbridge supply two separate ports for LAN on Motherboard (LOM) applications. The Marvell® Gigabit LAN controller is equipped with the net-diagnosing utility, VCT (Virtual Cable Tester), that intelligently diagnoses and reports cable faults from a remote location up to 100 meters. This feature helps maintain a more stable network connection. See pages 2-18, 5-17.

#### S/PDIF in/out function

The motherboard's S/PDIF out function turns your computer into a high-end entertainment system with digital connectivity.



## IEEE 1394 support

The IEEE 1394 interface provides high-speed and flexible PC connectivity to a wide range of peripherals and devices compliant to IEEE 1394a standards. The IEEE 1394 interface allows up to 400Mbps transfer rates through simple, low-cost, high-bandwidth asynchronous (real-time) data interfacing between computers, peripherals, and consumer electronic devices such as camcorders, VCRs, printers, TVs, and digital cameras. See page 2-25.

## 6-channel digital audio

The Realtek ALC650 AC'97 audio 6-channel CODEC works with the Audio Processing Unit (APU) integrated in the NVIDIA® NForce2™ MCP-T southbridge to provide 3D surround audio effects and Dolby® Digital cinematic-quality audio.

## 6 USB 2.0 ports

The motherboard implements the Universal Serial Bus (USB) 2.0 specification to provide up to 480Mbps connection speed. See page 2-24.

## 1.3.2 Unique ASUS features

### ASUS Wi-Fi slot

The ASUS Wi-Fi slot is based on the 802.11b/g wireless standard that is specifically designed for the ASUS WiFi-b™ add-on card to set up a wireless LAN environment. The ASUS WiFi-b™ add-on card bundles the Software AP (Access Point) to save the extra cost of a stand-alone AP. The card comes with user-friendly utilities and applications that allow quick connection to notebooks, PDAs, and other wireless LAN peripherals. See page 2-14.

### ASUS Q-Fan technology

The ASUS Q-Fan technology smartly adjusts the fan speeds according to the system loading to ensure quiet, cool, and efficient operation. See pages 4-29.

## ASUS POST Reporter™

The motherboard offers a new exciting feature called the ASUS POST Reporter™ to provide friendly voice messages and alerts during the Power-On Self-Tests (POST). Through an added external speaker, you will hear the messages informing you of the system boot status and causes of boot errors, if any. The bundled Winbond Voice Editor software allows you to customize the voice messages, and provides multi-language support. See page 3-3.

# ***Chapter 2***

This chapter lists the hardware setup procedures that you have to perform when installing system components. It includes description of the jumpers and connectors on the motherboard.

## **Hardware information**

## **Chapter summary**

<b>2.1</b>	<b>Before you proceed .....</b>	<b>2-1</b>
<b>2.2</b>	<b>Motherboard overview .....</b>	<b>2-2</b>
<b>2.3</b>	<b>Central Processing Unit (CPU) .....</b>	<b>2-6</b>
<b>2.4</b>	<b>System memory .....</b>	<b>2-8</b>
<b>2.5</b>	<b>Expansion slots .....</b>	<b>2-11</b>
<b>2.6</b>	<b>Jumpers .....</b>	<b>2-15</b>
<b>2.7</b>	<b>Connectors .....</b>	<b>2-18</b>

## 2.1 Before you proceed

Take note of the following precautions before you install motherboard components or change any motherboard settings.



1. Unplug the power cord from the wall socket before touching any component.
2. Use a grounded wrist strap or touch a safely grounded object or to a metal object, such as the power supply case, before handling components to avoid damaging them due to static electricity.
3. Hold components by the edges to avoid touching the ICs on them.
4. Whenever you uninstall any component, place it on a grounded antistatic pad or in the bag that came with the component.
5. **Before you install or remove any component, ensure that the ATX power supply is switched off or the power cord is detached from the power supply.** Failure to do so may cause severe damage to the motherboard, peripherals, and/or components.

### Onboard LED

The motherboard comes with a standby power LED. When lit, the green LED indicates that the system is ON, in sleep mode, or in soft-off mode, a reminder that you should shut down the system and unplug the power cable before removing or plugging in any motherboard component. The illustration below shows the location of the onboard LED.

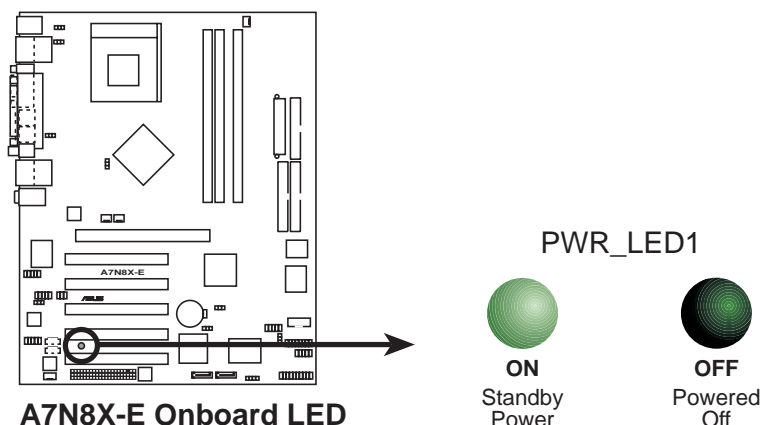

## 2.2 Motherboard overview

Before you install the motherboard, study the configuration of your chassis to ensure that the motherboard fits into it.



Make sure to unplug the power cord before installing or removing the motherboard. Failure to do so may cause you physical injury and damage motherboard components.

### 2.2.1 Placement direction

When installing the motherboard, make sure that you place it into the chassis in the correct orientation. The edge with external ports goes to the rear part of the chassis as indicated in the image below.

### 2.2.2 Screw holes

Place nine (9) screws into the holes indicated by circles to secure the motherboard to the chassis.



Do not overtighten the screws! Doing so may damage the motherboard.

Place this side towards the rear of the chassis

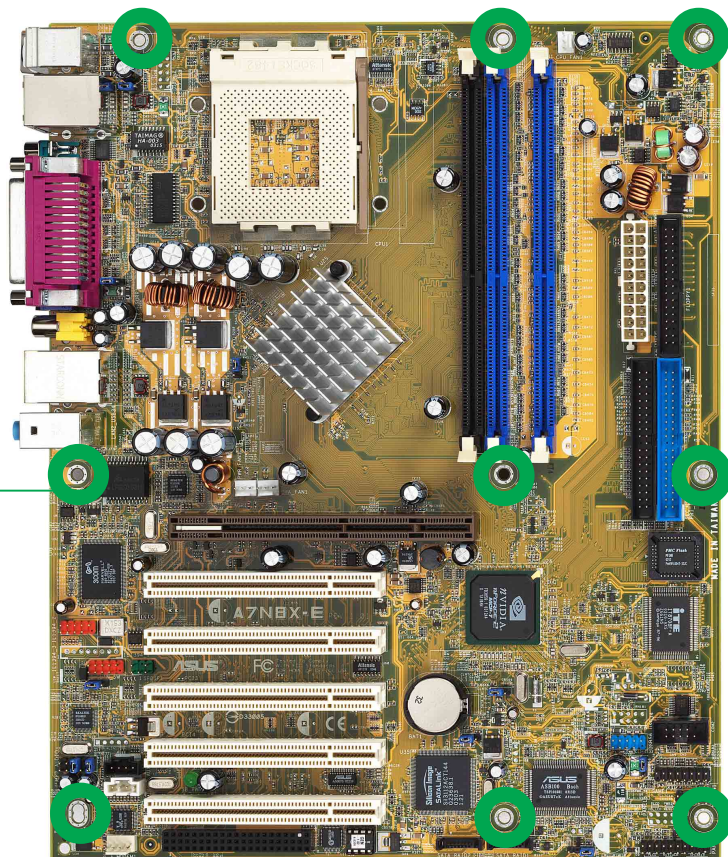

## 2.2.3 Motherboard layout

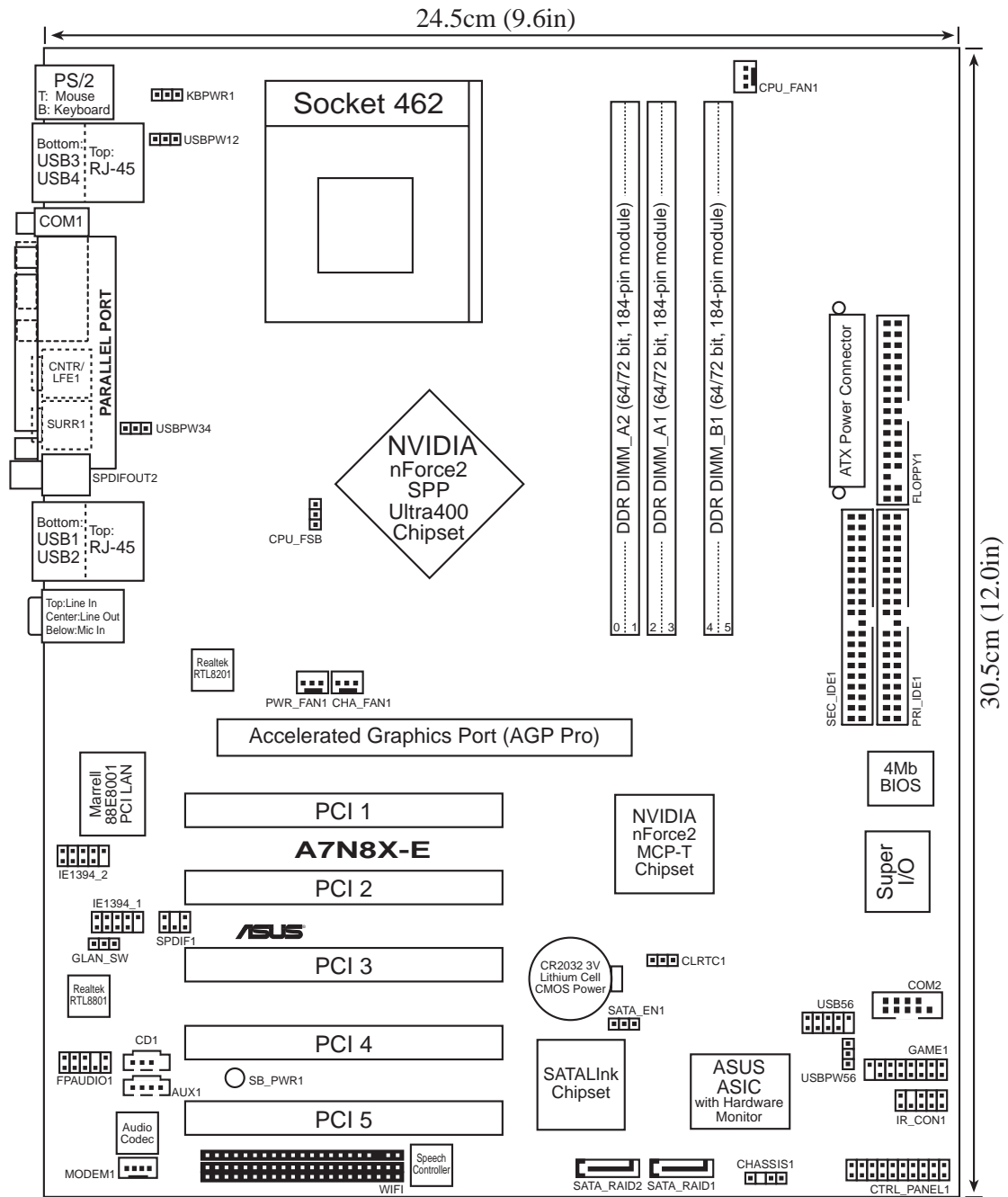

## 2.2.4 Layout Contents

<b>Slots</b>	
1. PCI slots	p. 2-13
2. AGP slot	p. 2-13
3. Wi-Fi slot	p. 2-14
4. DDR DIMM slots	p. 2-8

<b>Jumpers</b>	
1. Keyboard wake-up (3-pin KBPWR1)	p. 2-15
2. Central Processing Unit FSB Setting (3-pin CPU_FSB)	p. 2-15
3. USB device wake-up (3-pin USBPW12, USBPW34, USBPW56)	p. 2-16
4. Gigabit LAN Setting (3-pin GLAN_SW)	p. 2-16
5. Clear RTC RAM (3-pin CLRTC1)	p. 2-17
6. Serial ATA setting (3-pin SATA_EN1)	p. 2-17

<b>Rear Panel Connectors</b>	
1. PS/2 mouse port	p. 2-18
2. Fast Ethernet port (RJ-45)	p. 2-18
3. Parallel port	p. 2-18
4. Gigabit LAN port (RJ-45)	p. 2-18
5. Line In jack	p. 2-18
6. Line Out jack	p. 2-18
7. Microphone jack	p. 2-18
8. USB 2.0 ports 1 and 2	p. 2-18
9. S/PDIF out jack	p. 2-18
10. Surround L/R audio jack	p. 2-18
11. Center/LFE audio jack	p. 2-18
12. Serial connector	p. 2-18
13. USB 2.0 ports 3 and 4	p. 2-19
14. PS/2 keyboard port	p. 2-19



<b>Internal Connectors</b>	
1. Primary IDE connector (40-1 pin PRI_IDE)	p. 2-19
2. Secondary IDE connector (40-1 pin SEC_IDE)	p. 2-19
3. Floppy disk connector (34-1 pin FLOPPY1)	p. 2-20
4. Chassis intrusion connector (4-1 pin CHASSIS1)	p. 2-20
5. Serial ATA connectors (7-pin SATA_RAID1, SATA_RAID2 )	p. 2-21
6. CPU fan connector (3-pin CPU_FAN1)	p. 2-22
7. Power fan connector (3-pin PWR_FAN1)	p. 2-22
8. Chassis fan connector (3-pin CHA_FAN1)	p. 2-22
9. Serial Port 2 connector (10-1 pin COM2)	p. 2-22
10. ATX power connector (20-pin ATXPWR1)	p. 2-23
11. USB headers (10-1 pin USB56)	p. 2-24
12. MODEM connector (4-pin MODEM1)	p. 2-25
13. CD connector (4-pin CD1)	p. 2-25
14. AUX connector (4-pin AUX1)	p. 2-25
15. IEEE 1394 connectors (10-1 pin IE1394_1, IE1394_2)	p. 2-25
16. Front panel audio connector (10-1 pin FP_AUDIO)	p. 2-26
17. Digital audio connector (6-1 pin SPDIF1)	p. 2-26
18. GAME/MIDI connector (16-1 pin GAME1)	p. 2-27
19. Infrared module connector (10-1 pin IR_CON1)	p. 2-27
20. System panel connector (20-pin CTRL_PANEL1)	p. 2-28
- System Power LED Lead (Green 3-1 pin PLED)	
- Keyboard Lock Lead (Brown 2-pin KEYLOCK)	
- System Warning Speaker Lead (Orange 4-pin SPKR)	
- Reset Switch (Blue 2-pin RESET)	
- ATX Power Switch (Yellow 2-pin PWRBTN)	
- Hard Disk Activity LED (Red 2-pin IDE_LED)	

## 2.3 Central Processing Unit (CPU)

### 2.3.1 Overview

The motherboard comes with a surface mount 462-pin Zero Insertion Force (ZIF) socket designed for the AMD Athlon™, AMD Athlon™ XP and AMD Duron™ processors.

Take note of the marked corner (with gold triangle) on the CPU. This mark should match a specific corner on the socket to ensure correct installation.

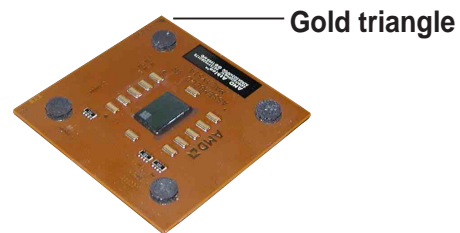

---

Do not use processors with core speeds of less than 1GHz on this motherboard.

---

### 2.3.2 Installing the CPU

Follow these steps to install a CPU.

1. Locate the 462-pin ZIF socket on the motherboard.

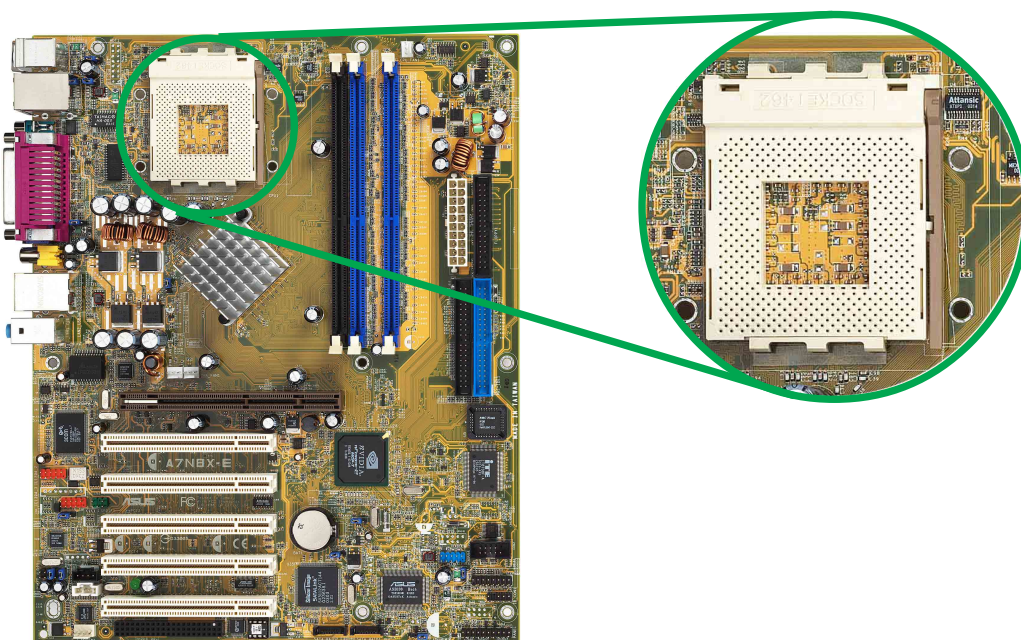

2. Unlock the socket by pressing the lever sideways, then lift it up to a 90°-100° angle.

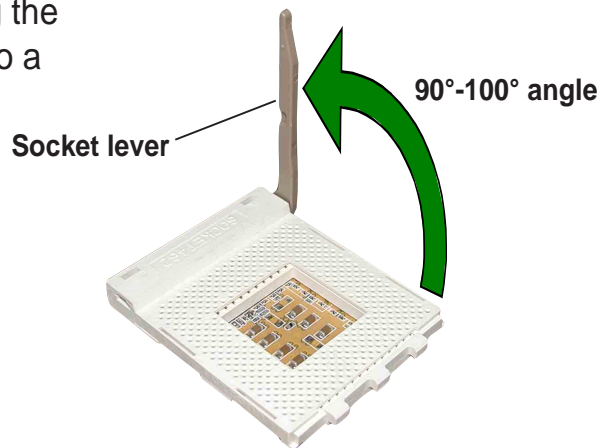

---

Make sure that the socket lever is lifted up to 90°-100° angle, otherwise the CPU does not fit in completely.

---

3. Position the CPU above the socket such that the CPU corner with the gold triangle matches the base of the socket lever.
4. Carefully insert the CPU into the socket until it fits in place.

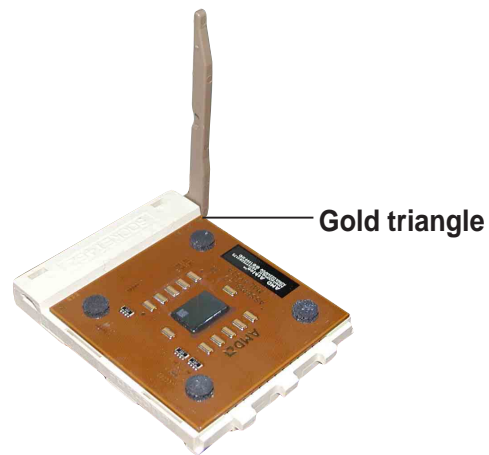

---

The CPU fits only in one correct orientation. DO NOT force the CPU into the socket to prevent bending the pins and damaging the CPU!

---

5. When the CPU is in place, push down the socket lever to secure the CPU. The lever clicks on the side tab to indicate that it is locked.

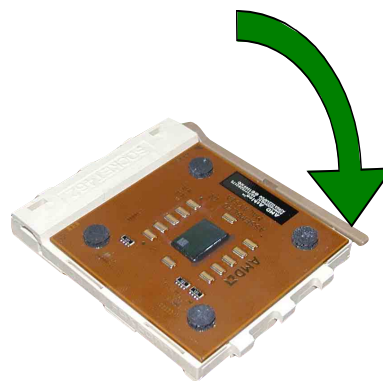

## 2.4 System memory

### 2.4.1 Overview

The motherboard comes with four Double Data Rate (DDR) Dual Inline Memory Module (DIMM) sockets.

The following figure illustrates the location of the sockets.

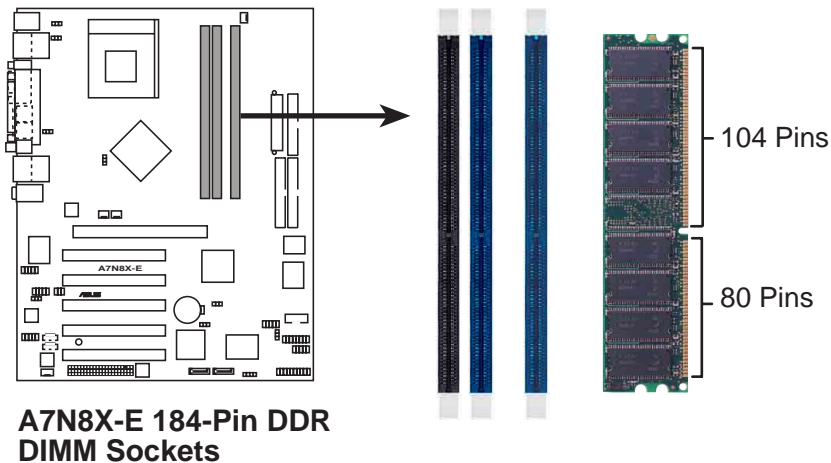

### 2.4.2 Memory configurations

You may install 64MB, 128MB, 256MB, 512MB, and 1GB DDR DIMMs into the DIMM sockets using the memory configurations in this section.

#### Important notes on memory configurations



1. Installing DDR DIMMs other than the recommended configurations may cause memory sizing error or system boot failure. Use any of the recommended configurations in Table 1.
2. Always install DIMMs with the same CAS latency. For optimum compatibility, it is recommended that you obtain memory modules from the same vendor.
3. DIMMs with more than 18 chips are not supported.
4. DIMMs with more than 8 devices on each side of the module are not supported.

**Table 1 Recommended memory configurations**

Mode		Sockets		
		DIMM_A1	DIMM_A2	DIMM_B1
Single-channel	(1)	Populated	—	—
	(2)	—	Populated	—
	(3)	—	—	Populated
Dual-channel*	(1)	Populated	—	Populated
	(2)	—	Populated	Populated
	(3)	Populated	Populated	Populated



---

Obtain DDR400 DIMMs only from ASUS qualified vendors for better system performance. Visit the ASUS website ([www.asus.com](http://www.asus.com)) for the latest qualified vendors list.

---

## 2.4.3 Installing a DIMM



Make sure to unplug the power supply before adding or removing DIMMs or other system components. Failure to do so may cause severe damage to both the motherboard and the components.

1. Unlock a DIMM socket by pressing the retaining clips outward.
2. Align a DIMM on the socket such that the notch on the DIMM matches the break on the socket.

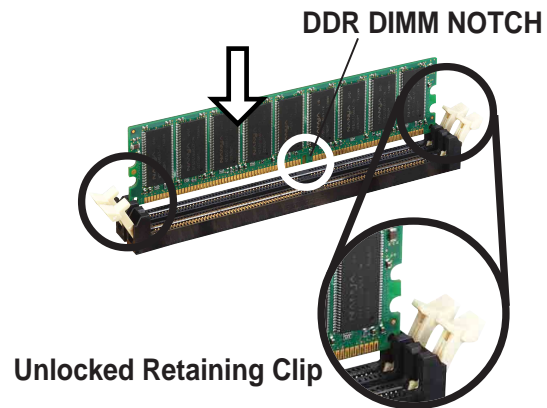

A DDR DIMM is keyed with a notch so that it fits in only one direction. **DO NOT** force a DIMM into a socket to avoid damaging the DIMM.

3. Firmly insert the DIMM into the socket until the retaining clips snap back in place and the DIMM is properly seated.

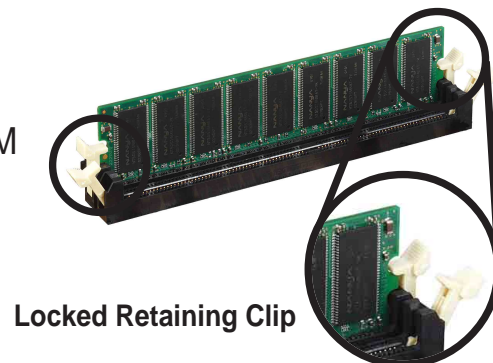

## 2.4.4 Removing a DIMM

Follow these steps to remove a DIMM.

1. Simultaneously press the retaining clips outward to unlock the DIMM.

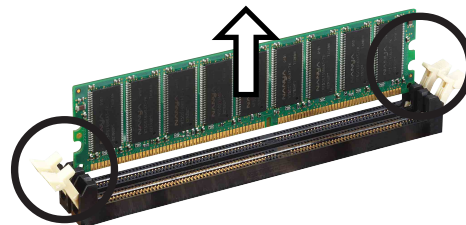

Support the DIMM lightly with your fingers when pressing the retaining clips. The DIMM might get damaged when it flips out with extra force.

2. Remove the DIMM from the socket.

## 2.5 Expansion slots



---

Make sure to unplug the power cord before adding or removing expansion cards. Failure to do so may cause you physical injury and damage motherboard components.

---

### 2.5.1 Installing an expansion card

Follow these steps to install an expansion card.

1. Before installing the expansion card, read the documentation that came with it and make the necessary hardware settings for the card.
2. Remove the system unit cover (if your motherboard is already installed in a chassis).
3. Remove the bracket opposite the slot that you intend to use. Keep the screw for later use.
4. Align the card connector with the slot and press firmly until the card is completely seated on the slot.
5. Secure the card to the chassis with the screw you removed earlier.
6. Replace the system cover.

### 2.5.2 Configuring an expansion card

After installing the expansion card, configure the card by adjusting the software settings.

1. Turn on the system and change the necessary BIOS settings, if any. See Chapter 4 for information on BIOS setup.
2. Assign an IRQ to the card. Refer to the tables on the next page.
3. Install the software drivers for the expansion card.

## 2.5.3 Interrupt assignments

### Standard Interrupt Assignments

IRQ	Priority	Standard Function
0	1	System Timer
1	2	Keyboard Controller
2	N/A	Programmable Interrupt
3*	11	Communications Port (COM2)
4*	12	Communications Port (COM1)
5*	13	Sound Card (sometimes LPT2)
6	14	Floppy Disk Controller
7*	15	Printer Port (LPT1)
8	3	System CMOS/Real Time Clock
9*	4	ACPI Mode when used
10*	5	IRQ Holder for PCI Steering
11*	6	IRQ Holder for PCI Steering
12*	7	PS/2 Compatible Mouse Port
13	8	Numeric Data Processor
14*	9	Primary IDE Channel
15*	10	Secondary IDE Channel

\* These IRQs are usually available for ISA or PCI devices.

### IRQ assignments for this motherboard

	PCI INT A	PCI INT B	PCI INT C	PCI INT D
PCI slot 1	shared	—	—	—
PCI slot 2	—	—	—	shared
PCI slot 3	—	—	shared	—
PCI slot 4	—	shared	—	—
PCI slot 5	shared	—	—	—
AGP slot	—	—	—	shared
Serial ATA	—	—	shared	—
Gigabit LAN	—	shared	—	—
WiFi slot	shared	—	—	—



When using PCI cards on shared slots, ensure that the drivers support “Share IRQ” or that the cards do not need IRQ assignments. Otherwise, conflicts will arise between the two PCI groups, making the system unstable and the card inoperable.



## 2.5.4 PCI slots

The PCI slots support PCI cards such as a LAN card, SCSI card, USB card, and other cards that comply with PCI specifications. The following figure shows a LAN card installed on a PCI slot.

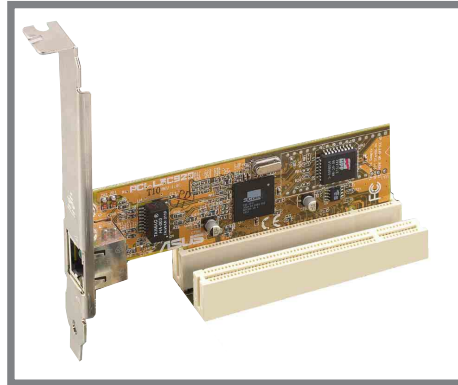

## 2.5.5 AGP slot

The Accelerated Graphics Port (AGP) slot that supports AGP8X/4X cards. When you buy an AGP card, make sure that you ask for one with +1.5V specification. Note the notches on the card golden fingers to ensure that they fit the AGP slot on your motherboard.



Install only 1.5V AGP cards on this motherboard! 3.3V AGP cards are not supported in this motherboard.

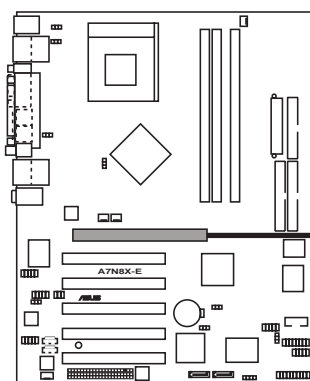

**A7N8X-E Accelerated Graphics Port (AGP8X)**

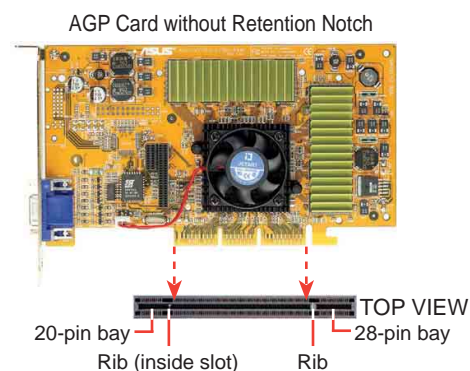

## 2.5.6 Wi-Fi slot

The Wi-Fi (Wireless Fidelity) slot will support the ASUS WiFi-b™ module when available. Visit the ASUS website ([www.asus.com](http://www.asus.com)) for product updates.

The Wi-Fi slot conforms to the Institute of Electrical and Electronics Engineers (IEEE) 802.11b/g standard for wireless devices operating in the 2.4 GHz frequency band.

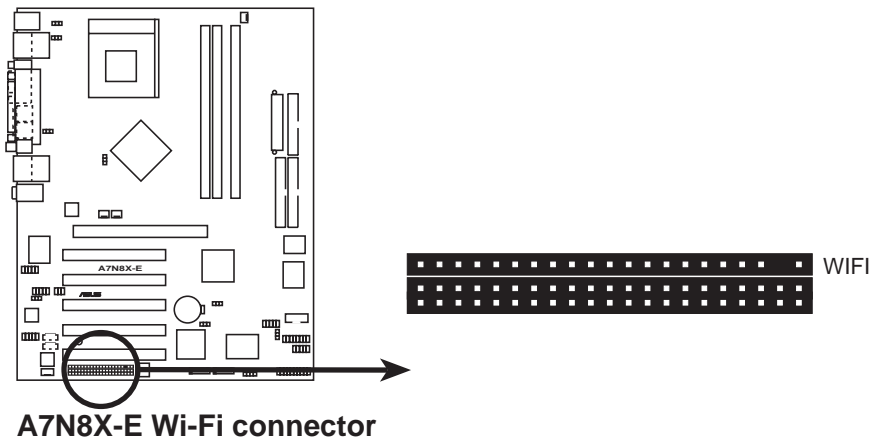

### ASUS WiFi-b™ Setup



- The PCI 5 slot and the WiFi slot can not be used at the same time.
- The Wi-Fi module is purchased separately.

## 2.6 Jumpers

### 1. Keyboard wake up (3-pin KBPWR1)

This jumper allows you to enable or disable the keyboard wake-up feature. Set this jumper to pins 2-3 (+5VSB) if you wish to wake up the computer when you press a key on the keyboard. This feature requires an ATX power supply that can supply at least 1A on the +5VSB lead, and a corresponding setting in the BIOS.

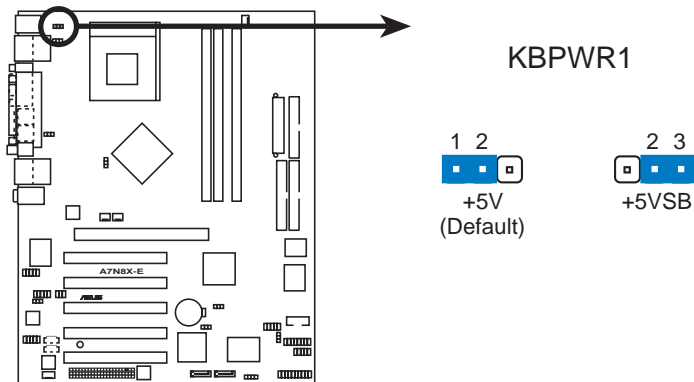

**A7N8X-E Keyboard Power Setting**

### 2. Central Processing Unit FSB (CPU\_FSB)

When set to pins 1-2 (default), this jumper enables support for 400MHz, 333MHz, or 266MHz Front Side Bus (FSB). Set to pins 2-3 to support 200 MHz FSB only.

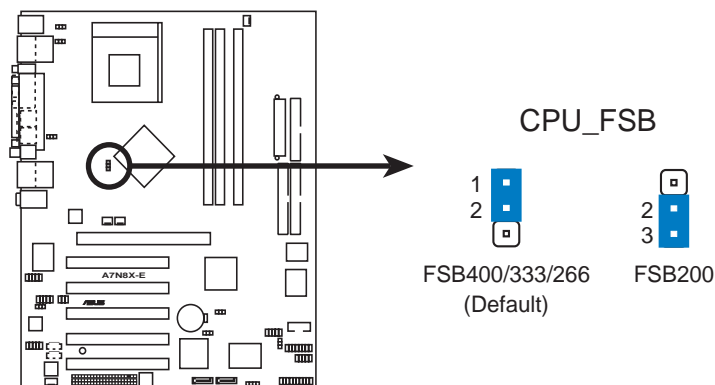

**A7N8X-E CPU FSB Jumper Setting**



When using an AMD Duron™ processor, change the CPU\_FSB jumper setting to pins 2-3.

- 3. USB device wake-up (3-pin USBPW12, USBPW34, USBPW56)**  
 Set these jumpers to +5V to wake up the computer from S1 sleep mode (CPU stopped, DRAM refreshed, system running in low power mode) using the connected USB devices. Set to +5VSB to wake up from S3 and S4 sleep modes (no power to CPU, DRAM in slow refresh, power supply in reduced power mode).

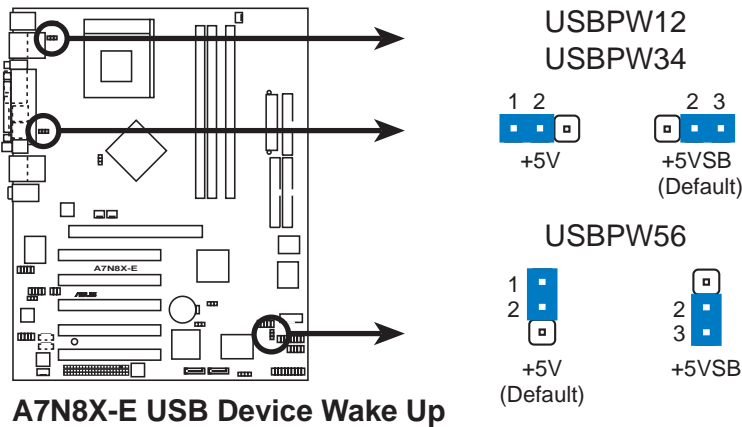

**A7N8X-E USB Device Wake Up**



- The USB device wake-up feature requires a power supply that can provide 500mA on the +5VSB lead for each USB port. Otherwise, the system would not power up.
- The total current consumed must NOT exceed the power supply capability (+5VSB) whether under normal condition or in sleep mode.

- 4. Gigabit LAN switch setting (3-pin GLAN\_SW)**  
 This jumper enables or disables the Gigabit LAN controller.

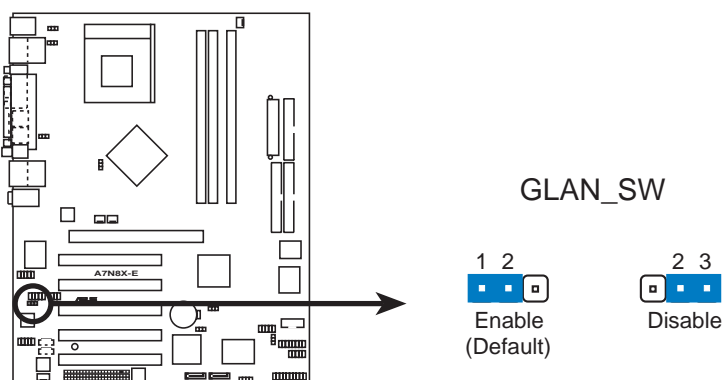

**A7N8X-E Gigabit LAN Switch Setting**

## 5. Clear RTC RAM (CLRTC1)

This jumper clears the Real Time Clock (RTC) RAM of date, time, and system setup parameters in CMOS. The RAM data in CMOS is powered by the onboard button cell battery.

To erase the RTC RAM:

1. Turn OFF the computer and unplug the power cord.
2. Remove the battery.
3. Move the jumper caps from pins 1-2 (default) to pins 2-3. Keep the cap on pins 2-3 for about 5~10 seconds then move the cap back to pins 1-2.
4. Replace the battery.
5. Plug the power cord and turn ON the computer.
6. Hold down the <Del> key during the boot process and enter BIOS setup to re-enter data.

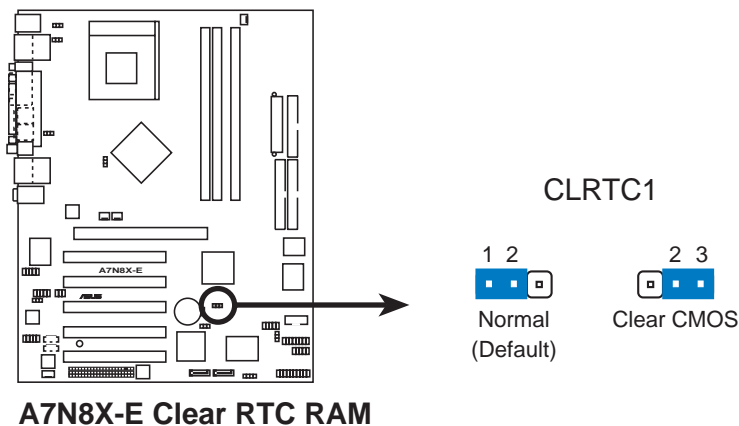

## 6. Serial ATA setting (3-pin SATA\_EN1)

This jumper enables or disables the Serial ATA controllers.

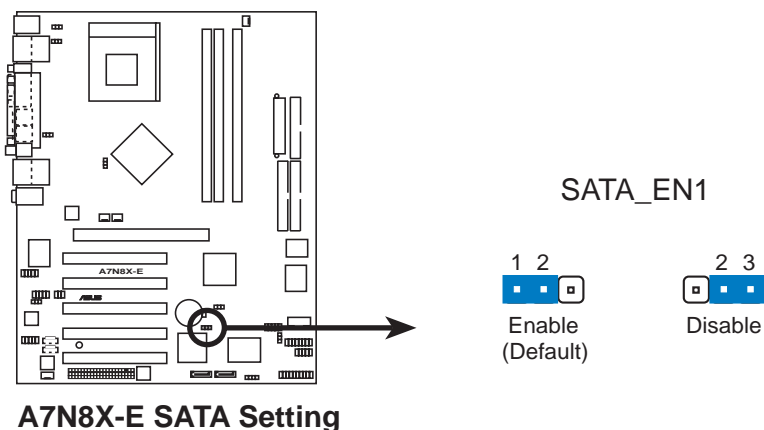

## 2.7 Connectors

### 2.7.1 Rear panel connectors

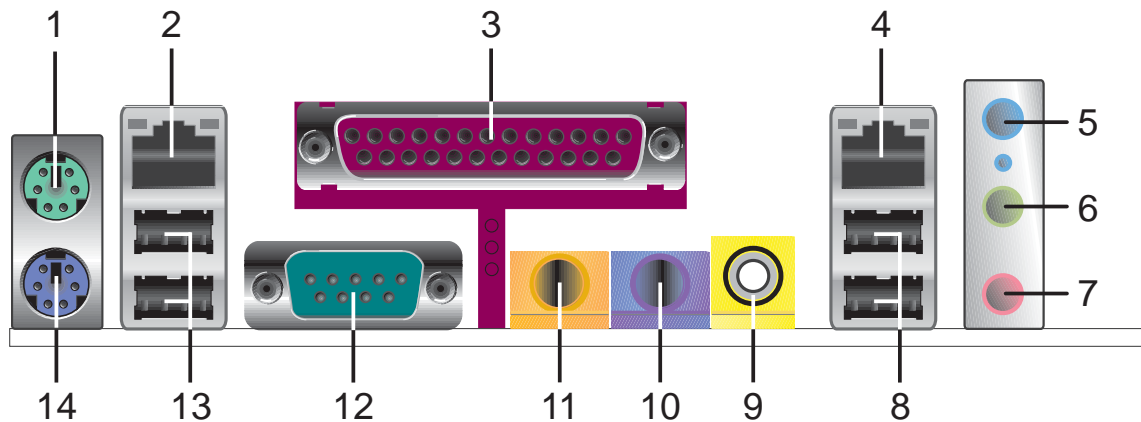

1. **PS/2 mouse port.** This green 6-pin connector is for a PS/2 mouse.
2. **Fast Ethernet port (RJ-45).** This port allows up to 100 Mbps of data transfer rate to a Local Area Network (LAN).
3. **Parallel port.** This 25-pin port connects a parallel printer, a scanner, or other devices.
4. **Gigabit LAN port (RJ-45).** This port allows up to 1 Gigabit of data transfer rate to a Local Area Network (LAN).
5. **Line In jack.** This Line In (light blue) jack connects a tape player or other audio sources. In 6-channel mode, the function of this jack becomes Bass/Center.
6. **Line Out jack.** This Line Out (lime) jack connects a headphone or a speaker. In 4-channel and 6-channel mode, the function of this jack becomes Front Speaker Out.
7. **Microphone jack.** This Mic (pink) jack connects a microphone. In 4-channel and 6-channel modes, the function of this jack becomes Rear Speaker Out.
8. **USB 2.0 ports 1 and 2.** These two 4-pin Universal Serial Bus (USB) ports are available for connecting USB 2.0 devices.
9. **S/PDIF out jack.** This jack connects to external S/PDIF audio devices.
10. **Surround L/R audio jack.** This (purple) jack connects to the left/right surround speakers.
11. **Center/LFE audio jack.** This (yellow-orange) jack connects to the center speakers or bass speakers.
12. **Serial connector.** This 9-pin COM1 port is for serial devices.

**13. USB 2.0 ports 3 and 4.** These two 4-pin Universal Serial Bus (USB) ports are available for connecting USB 2.0 devices.

**14. PS/2 keyboard port.** This purple connector is for a PS/2 keyboard.

## 2.7.2 Internal connectors

### 1. IDE connectors (40-pin PRI\_IDE1, SEC\_IDE1)

This connector supports the provided UltraATA100 IDE hard disk ribbon cable. Connect the cable's blue connector to the primary (recommended) or secondary IDE connector, then connect the gray connector to the UltraATA100 slave device (hard disk drive) and the black connector to the UltraATA100 master device.



1. Follow the hard disk drive documentation when setting the device in master or slave mode.
2. Pin 20 on each IDE connector is removed to match the covered hole on the UltraATA cable connector. This prevents incorrect orientation when you connect the cables.
3. The hole near the blue connector on the UltraATA cable is intentional.

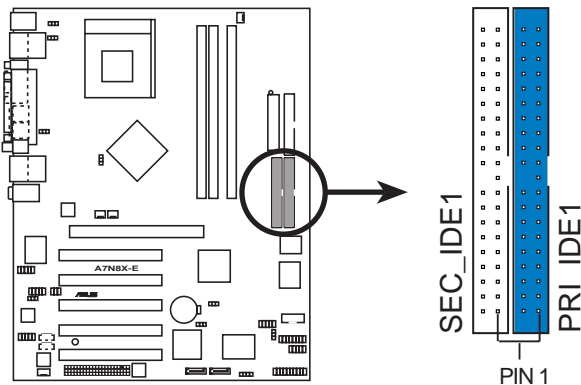

**A7N8X-E IDE Connectors**

**NOTE:** Orient the red markings (usually zigzag) on the IDE ribbon cable to PIN 1.

## 2. Floppy disk drive connector (34-1 pin FLOPPY1)

This connector supports the provided floppy drive ribbon cable. After connecting one end to the motherboard, connect the other end to the floppy drive. (Pin 5 is removed to prevent incorrect insertion when using ribbon cables with pin 5 plug).

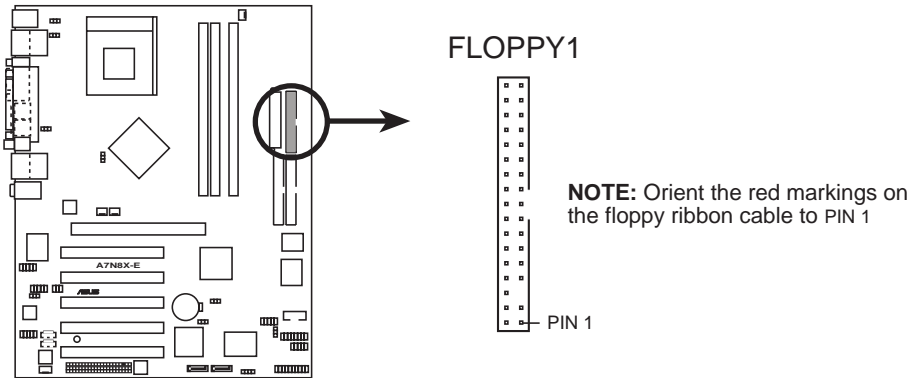

**A7N8X-E Floppy Disk Drive Connector**

## 3. Chassis intrusion connector (4-1 pin CHASSIS1)

This lead is for a chassis designed with intrusion detection feature. This requires an external detection mechanism such as a chassis intrusion sensor or microswitch. When you remove any chassis component, the sensor triggers and sends a high-level signal to this lead to record a chassis intrusion event.

By default, the pins labeled “Chassis Signal” and “Ground” are shorted with a jumper cap. If you wish to use the chassis intrusion detection feature, remove the jumper cap from the pins.

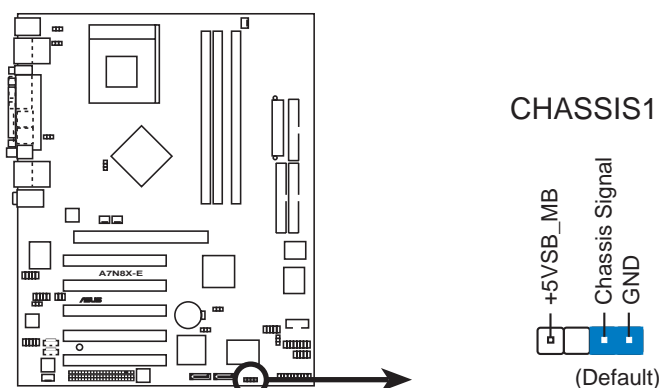

**A7N8X-E intrusion connector**



#### 4. Serial ATA connectors (7-pin SATA\_RAID1, SATA\_RAID2)

These Serial ATA connectors support SATA hard disks that you may configure as a RAID set. Through the onboard Promise® PDC20378 RAID controller, you may create a RAID0, RAID1, RAID0+1, or multi-RAID configuration together with the RAID ATA133 connector. See Chapter 5 for details on RAID configuration.

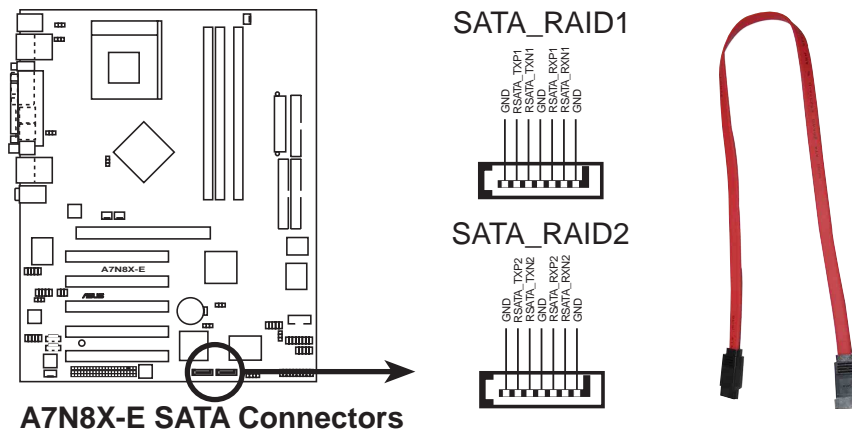

#### Important notes on Serial ATA solution:

- Hot plug support for Serial ATA drive and connections are not available in this motherboard.
- Install Windows® XP™ Service Pack 1 when using Serial ATA.

## 5. CPU, Power and Chassis Fan Connectors (3-pin CPU\_FAN1, PWR\_FAN1, CHA\_FAN1)

The fan connectors support cooling fans of 350mA~740mA (8.88W max.) or a total of 1A~2.22A (26.64W max.) at +12V. Connect the fan cables to the fan connectors on the motherboard, making sure that the black wire of each cable matches the ground pin of the connector.



Do not forget to connect the fan cables to the fan connectors. Lack of sufficient air flow within the system may damage the motherboard components. These are not jumpers! **DO NOT** place jumper caps on the fan connectors!

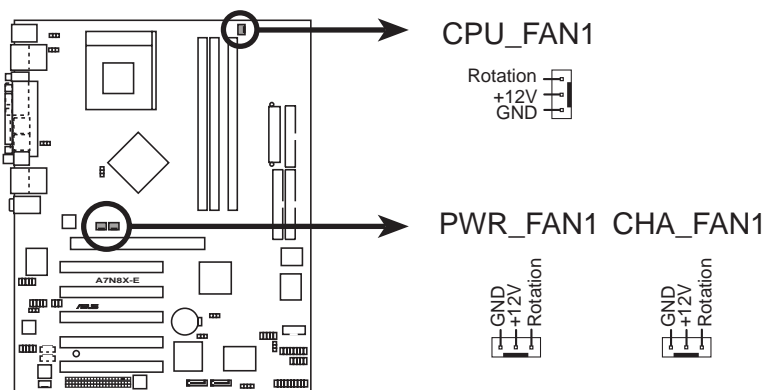

**A7N8X-E 12-Volt Cooling Fan Power**

## 6. Serial Port connector (10-1 pin COM2)

This connector accommodates a second serial port using a serial port bracket. Connect the bracket cable to this connector then install the bracket into a slot opening at the back of the system chassis.

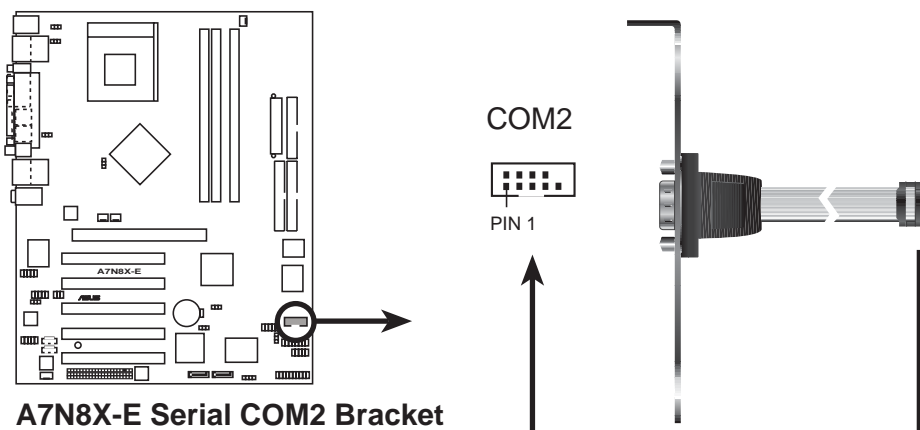

**A7N8X-E Serial COM2 Bracket**



The serial port bracket is purchased separately.

## 7. ATX power connectors (20-pin ATXPWR1)

This connector connects to an ATX 12V power supply. The plugs from the power supply is designed to fit this connectors in only one orientation. Find the proper orientation and push down firmly until the connector completely fits.



---

Make sure that your ATX 12V power supply can provide 8A on the +12V lead and at least 1A on the +5-volt standby lead (+5VSB). The minimum recommended wattage is 300W, or 350W for a fully configured system. The system may become unstable or may not boot up if the power is inadequate.

---

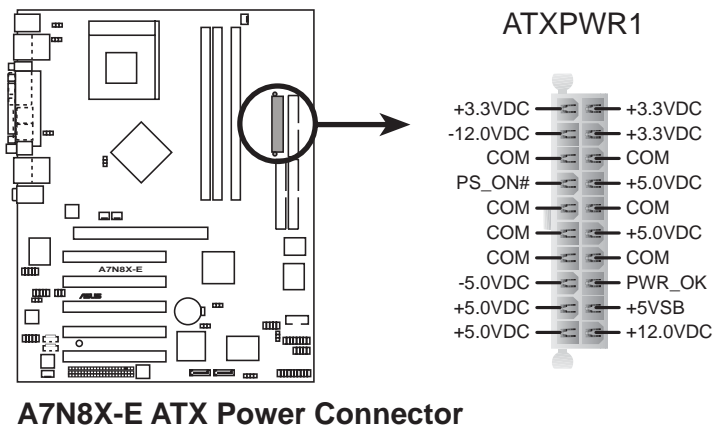

## 8. USB header (10-1 pin USB56)

If the USB ports on the rear panel are inadequate, a USB header is available for additional USB ports. The USB header complies with USB 2.0 specification that supports up to 480 Mbps connection speed and allows faster Internet connection, interactive gaming, and simultaneous running of high-speed peripherals.



---

You must install the driver before you can use the USB 2.0 capability.

---

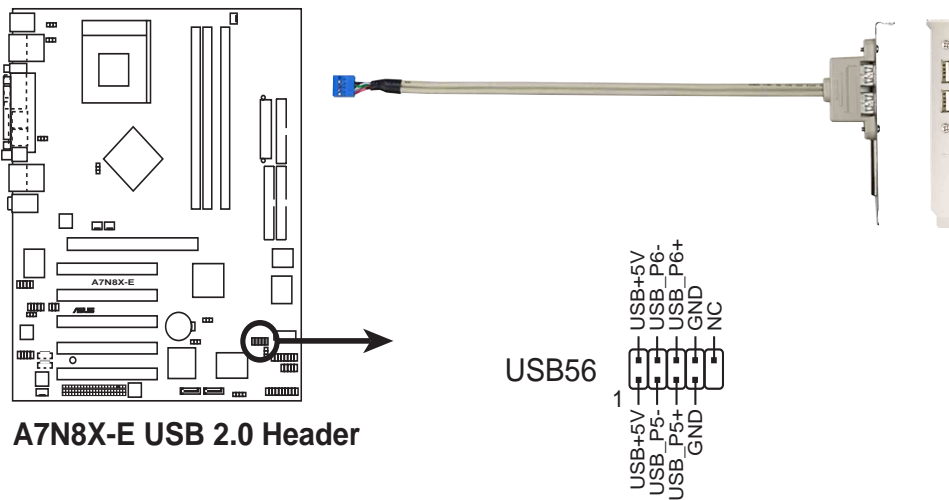

---

NEVER connect a **1394 cable** to the USB connector. Doing so will damage the motherboard!

---

## 9. Internal audio connectors (4-pin MODEM1, CD1, AUX1)

These connectors allow you to receive stereo audio input from sound sources such as a CD-ROM, TV tuner, or MPEG card. The modem connector allows the onboard audio to interface with a voice modem card with a similar connector. It also allows the sharing of mono\_in (such as phone) and a mono\_out (such as a speaker) between the audio and a voice modem card.

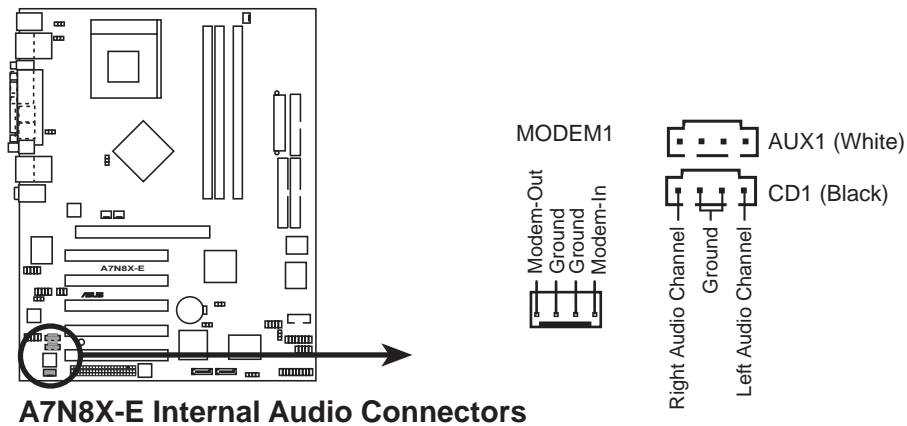

## 10. IEEE 1394 connectors (10-1 pin IE1394\_1, IE1394\_2)

These connectors are for IEEE 1394 modules. Attach the 10-1 pin cable plugs to these connectors. You may also connect a 1394-compliant internal hard disk to these connectors.

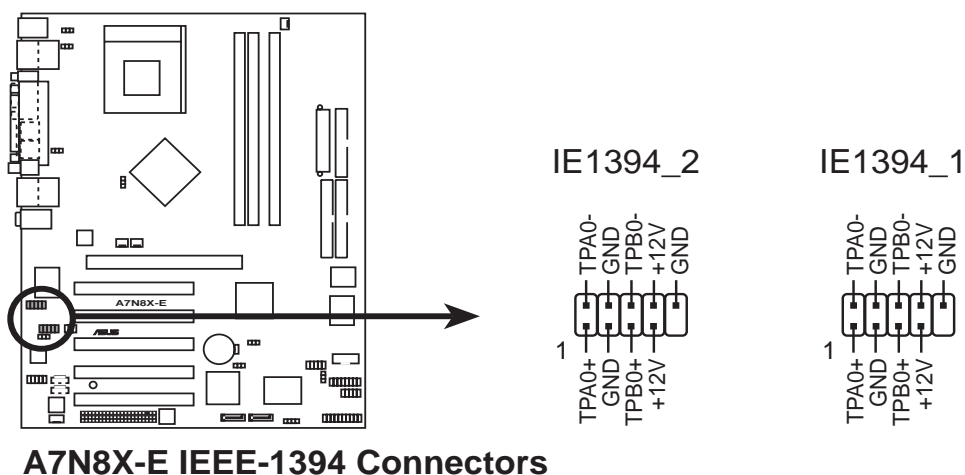

NEVER connect a **USB cable** to any of the IEEE 1394 (orange) connectors. Doing so will damage the motherboard!

## 11. Front panel audio connector (10-1 pin FP\_AUDIO)

This is an interface for the front panel audio cable that allow convenient connection and control of audio devices.

By default, the pins labeled LINE\_OUT\_R/BLINE\_OUT\_R and the pins LINE\_OUT\_L/BLINE\_OUT\_L are shorted with jumper caps. Remove the caps only when you are connecting the front panel audio cable.

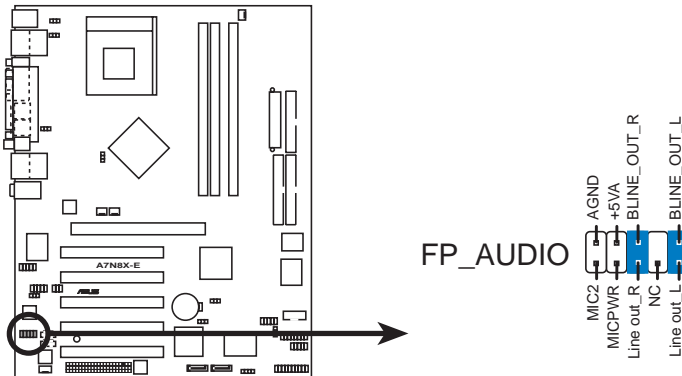

**A7N8X-E Front Panel Audio Connector**

## 12. Digital Audio connector (6-1 pin SPDIF1)

This connector is for the S/PDIF audio module to allow digital sound input/output. Connect one end of the S/PDIF audio cable to this connector and the other end to the S/PDIF module.

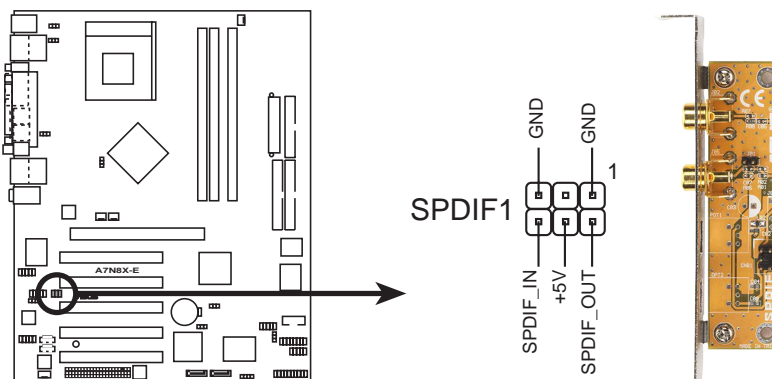

**A7N8X-E Digital Audio Connector**



---

The S/PDIF module is purchased separately.

---

### 13. GAME/MIDI connector (16-1 pin GAME1)

This connector supports a GAME/MIDI module. If a GAME/MIDI module is available, connect the GAME/MIDI cable to this connector. The GAME/MIDI port on the module connects a joystick or a game pad for playing games, and MIDI devices for playing or editing audio files.

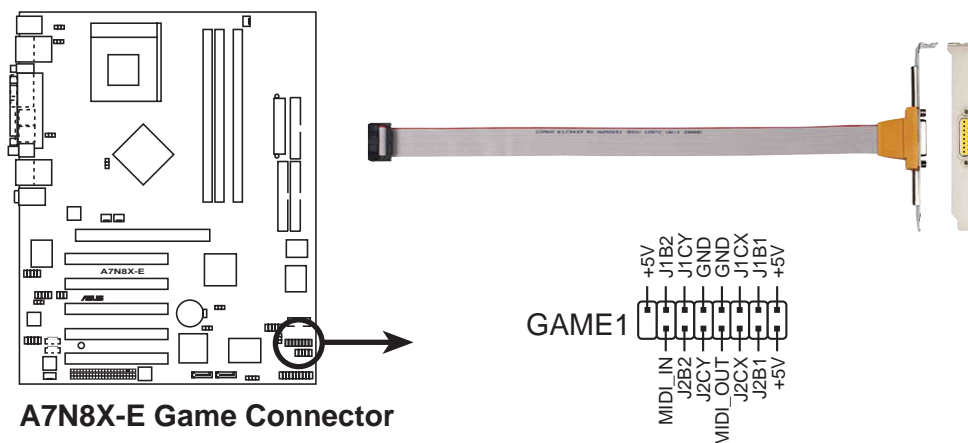

A7N8X-E Game Connector



The GAME/MIDI module is purchased separately.

### 14. Infrared Module connector (10-1 pin IR\_CON1)

This connector supports an optional wireless transmitting and receiving infrared module. The module mounts to a small opening on the system chassis that support this feature.



Make sure to configure the **UART2 Use As** parameter in the BIOS to set the UART2 to use with IR.

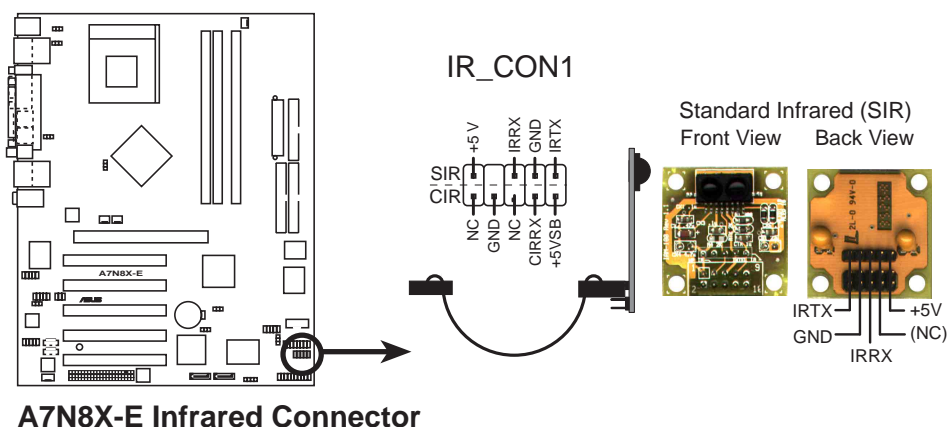

A7N8X-E Infrared Connector

## 15. System panel connector (20-pin CTRL\_PANEL1)

This connector accommodates several system front panel functions.

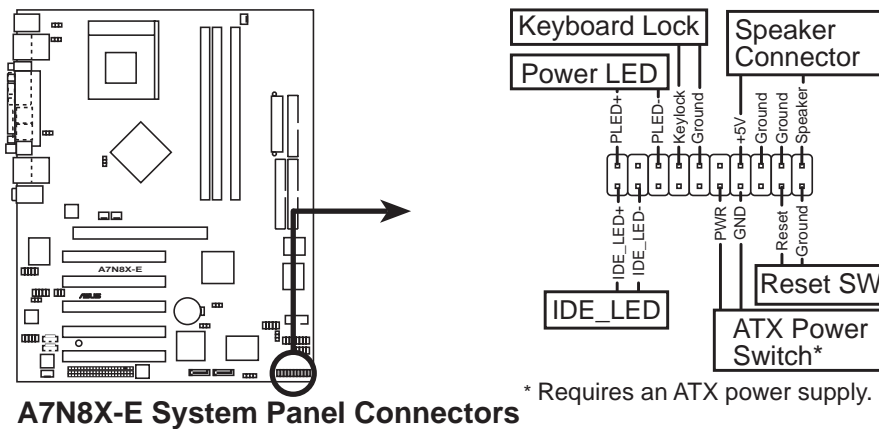

- **System Power LED Lead (Green 3-1 pin PLED)**  
This 3-1 pin connector connects to the system power LED. The LED lights up when you turn on the system power, and blinks when the system is in sleep mode.
- **Keyboard Lock Lead (Brown 2-pin KEYLOCK)**  
This 2-pin connector connects to a chassis-mounted switch to allow the use of the keyboard lock feature.
- **System Warning Speaker Lead (Orange 4-pin SPKR)**  
This 4-pin connector connects to the case-mounted speaker and allows you to hear system beeps and warnings.
- **Reset Switch Lead (Blue 2-pin RESET)**  
This 2-pin connector connects to the case-mounted reset switch for rebooting the system without turning off the system power.
- **ATX Power Switch / Soft-Off Switch Lead (Yellow 2-pin PWRBTN)**  
This connector connects a switch that controls the system power. Pressing the power switch turns the system between ON and SLEEP, or ON and SOFT OFF, depending on the BIOS or OS settings. Pressing the power switch while in the ON mode for more than 4 seconds turns the system OFF.
- **Hard disk activity LED (Red 2-pin IDE\_LED)**  
This connector supplies power to the hard disk activity LED. Any read or write activity of an IDE device cause this LED to light up.



The System Panel connector is color-coded for easy and foolproof connection. Take note of the specific connector colors as described.



# ***Chapter 3***

This chapter describes the power up sequence, the vocal POST messages and ways of shutting down the system.

## **Powering up**

## **Chapter summary**

<b>3.1</b>	<b>Starting up for the first time .....</b>	<b>3-1</b>
<b>3.2</b>	<b>Powering off the computer .....</b>	<b>3-2</b>
<b>3.3</b>	<b>ASUS POST Reporter™ .....</b>	<b>3-4</b>

## 3.1 Starting up for the first time

1. After making all the connections, replace the system case cover.
2. Be sure that all switches are off.
3. Connect the power cord to the power connector at the back of the system chassis.
4. Connect the power cord to a power outlet that is equipped with a surge protector.
5. Turn on the devices in the following order:
  - a. Monitor
  - b. External SCSI devices (starting with the last device on the chain)
  - c. System power (if you are using an ATX power supply, you need to switch on the power supply as well as press the ATX power switch on the front of the chassis).
6. After applying power, the power LED on the system front panel case lights up. For ATX power supplies, the system LED lights up when you press the ATX power switch. If your monitor complies with “green” standards or if it has a “power standby” feature, the monitor LED may light up or switch between orange and green after the system LED turns on. The system then runs the power-on tests. While the tests are running, the BIOS beeps or additional messages appear on the screen. If you do not see anything within 30 seconds from the time you turned on the power, the system may have failed a power-on test. Check the jumper settings and connections or call your retailer for assistance.
7. At power on, hold down <Delete> to enter BIOS Setup. Follow the instructions in Chapter 4.

## 3.2 Powering off the computer

### 3.2.1 Using the OS shut down function

If you are using Windows 98/98SE/ME/NT/2000, click the **Start** button, click **Shut Down...**, make sure that the **Shut down** option button is selected, then the **OK** button to shut down the computer. The power supply should turn off after Windows shuts down.

If you are using Windows XP, click the **Start** button, click **Turn Off Computer**, then the **Turn Off** button to shut down the computer. The power supply should turn off after Windows shuts down.

### 3.2.2 Using the dual function power switch

While the system is ON, pressing the power switch for less than 4 seconds puts the system to sleep mode or to soft-off mode, depending on the BIOS setting. Pressing the power switch for more than 4 seconds lets the system enter the soft-off mode regardless of the BIOS setting. See section “4.5 Power Menu” in Chapter 4.

## 3.3 ASUS POST Reporter™

This motherboard includes the Winbond speech controller to support a special feature called the ASUS POST Reporter™. This feature gives you vocal POST messages and alerts to inform you of system events and boot status. In case of a boot failure, you will hear the specific cause of the problem.

These POST messages are customizable using the Winbond Voice Editor software that came with your package. You can record your own messages to replace the default messages.

### 3.3.1 Vocal POST messages

Following is a list of the default POST messages and their corresponding actions:

POST Message	Action
No CPU installed	<ul style="list-style-type: none"><li>• Install a supported processor into the CPU socket. See section “2.3 Central Processing Unit (CPU)” for supported processors.</li></ul>
System failed CPU test	<ul style="list-style-type: none"><li>• Check the CPU if properly installed.</li><li>• Call ASUS technical support for assistance. See the “ASUS contact information” on the inside front cover of this manual.</li></ul>
System failed memory test	<ul style="list-style-type: none"><li>• Install supported DDR DIMMs into the sockets.</li><li>• Check if the DIMMs on the DIMM sockets are properly installed.</li><li>• Make sure that your DIMMs are not defective.</li><li>• Refer to section “2.4 System memory” for instruction on installing a DIMM.</li></ul>
System failed VGA test	<ul style="list-style-type: none"><li>• Install a PCI VGA card into one of the PCI slots, or a 1.5V AGP card into the AGP slot.</li><li>• Make sure that your VGA/AGP card is not defective.</li></ul>
System failed due to CPU over-clocking	<ul style="list-style-type: none"><li>• Check your CPU settings in BIOS and make sure you only set to the recommended settings. See section “4.4 Advanced menu.”</li></ul>

POST Message	Action
No keyboard detected	<ul style="list-style-type: none"> <li>• Check your keyboard if properly connected to the purple PS/2 connector on the rear panel.</li> <li>• See section “2.7.1 Rear panel connectors” for the location of the connector.</li> </ul>
No floppy disk detected	<ul style="list-style-type: none"> <li>• Make sure you have connected a floppy disk to the floppy disk connector on the motherboard.</li> </ul>
No IDE hard disk detected	<ul style="list-style-type: none"> <li>• Make sure you have connected an IDE hard disk drive to the one of the IDE connectors on the motherboard.</li> </ul>
CPU temperature too high	<ul style="list-style-type: none"> <li>• Check CPU fan if working properly.</li> </ul>
CPU fan failed	<ul style="list-style-type: none"> <li>• Check the CPU fan and make sure it turns on after you applied power to the system.</li> <li>• Make sure that your CPU fan supports the fan speed detection function.</li> </ul>
CPU voltage out of range	<ul style="list-style-type: none"> <li>• Check your power supply and make sure it is not defective.</li> <li>• Call ASUS technical support for assistance. See the “ASUS contact information” on the inside front cover of this manual.</li> </ul>
System completed Power-On Self Test	<ul style="list-style-type: none"> <li>• No action required</li> </ul>
Computer now booting from operating system	<ul style="list-style-type: none"> <li>• No action required</li> </ul>



You may disable the ASUS POST Reporter™ in the BIOS setup. See section “4.4.6 Speech Configuration”.

## 3.3.2 Winbond Voice Editor

The Winbond Voice Editor software allows you to customize the vocal POST messages. Install the software from the utilities menu of the support CD. See section “5.2.3 Utilities menu” for details.



---

To avoid conflicts, do not run the Winbond Voice Editor while running the ASUS PC Probe.

---

Follow these steps to use the Winbond Voice Editor.

### Launching the program

Launch the program either from the Winbond Voice Editor icon on your desktop, or from the Windows Start menu, **Programs/Winbond Voice Editor/Voice Editor**.

The Winbond Voice Editor screen appears.



Default Messages

POST Events

### Playing the default wave files

To play the default wave files, simply click on a POST event on the left side of the screen, then click the Play button.



---

The default language setting is English.

---

## Changing the default language

1. Click on the Load button. a window showing the available languages appears.
2. Select your desired language then click Open. The event messages for the language you selected appear on the Voice Editor screen.



For some languages, not all events have a corresponding message due to file size constraints.

3. Click on the Write button to update the EEPROM.
4. Click Yes on the confirmation window that appears.



The next time you boot your computer, the POST messages are announced in the language that you selected .



## Customizing your POST messages

If your language is not in the selection or if you wish to record your own POST messages to replace the pre-installed wave files, you may easily do so.

Follow these steps to customize your POST messages.

1. Launch the Voice Editor and take note of the list of POST events on the leftmost column of the screen.
2. Prepare your message for each event.



---

The total compressed size for all the wave files must not exceed 1Mbit, so make your messages as short as possible.

---

3. Use a recording software, such as Windows Recorder, to record your messages.
4. Save the messages as wave files (.WAV). It is recommended that you save your files in low quality to keep them small. For example, use 8-bit, mono quality at 22Khz sampling rate.



---

You may want to create a separate folder for your wave files so you can locate them easily in one place.

---

5. From the Voice Editor screen, click on the Add button to display the Add Wave File window.
6. Copy the wave files that you recorded to the database. Close the window when done.

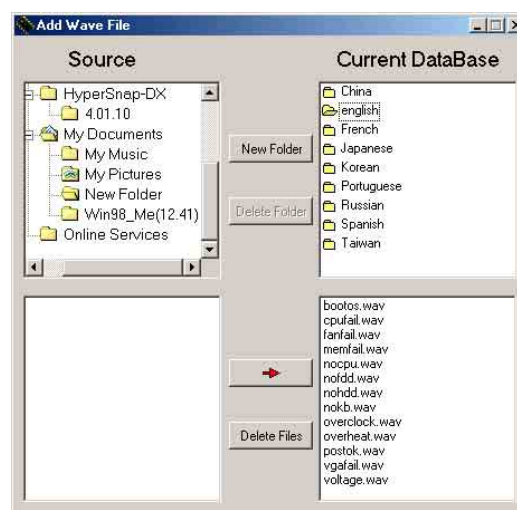

7. Click a POST event on the Voice Editor screen, then on the Edit button. The Event Sound Editor window appears.
8. Locate and select your wave file for the event then click on the arrow opposite Voice1. The file you selected appears on the space next to it.
9. Click OK to return to the Voice Editor screen.
10. Do steps 7 to 9 for the other events.
11. When done, click the Save button. A window appears prompting you to save your configuration.
12. Type a file name with a .flh extension, then click Save.
13. Click on the Write button to compress the file and copy into the EEPROM.
14. Click Yes on the confirmation window that appears.

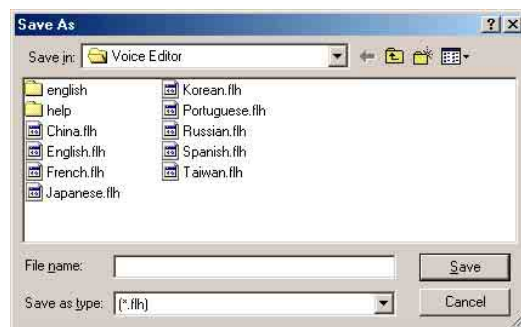
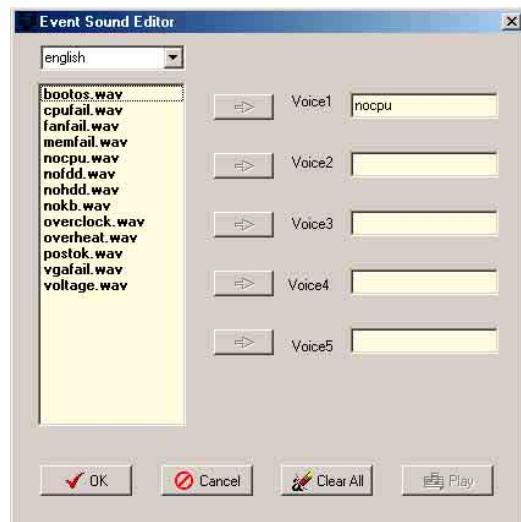

If you receive an error message telling you that the files exceed the total allowable size, do one or all of the following.

- Try to modify your messages to make them shorter
- Save the wave files at a lower quality
- Skip lesser used events like FDD Detection, IDE HDD Detection, etc.

# ***Chapter 4***

This chapter tells how to change the system settings through the BIOS Setup menus. Detailed descriptions of the BIOS parameters are also provided.

## **BIOS setup**

## **Chapter summary**

<b>4.1</b>	<b>Managing and updating your BIOS .....</b>	<b>4-1</b>
<b>4.2</b>	<b>BIOS Setup program .....</b>	<b>4-7</b>
<b>4.3</b>	<b>Main Menu .....</b>	<b>4-10</b>
<b>4.4</b>	<b>Advanced Menu .....</b>	<b>4-14</b>
<b>4.5</b>	<b>Security Menu .....</b>	<b>4-27</b>
<b>4.6</b>	<b>Hardware Monitor Menu .....</b>	<b>4-29</b>
<b>4.7</b>	<b>Exit Menu .....</b>	<b>4-30</b>

## 4.1 Managing and updating your BIOS

The following utilities allow you to manage and update the motherboard Basic Input/Output System (BIOS) setup.

1. **Award Flash BIOS Utility** (*Updates the BIOS using a floppy disk or during POST.*)
2. **ASUS Update** (*Updates the BIOS in a Windows® environment.*)

Refer to the corresponding sections for details on these utilities.

### Important notes



---

It is recommended that you save a copy of the **original motherboard BIOS file** to a **bootable floppy disk** in case you need to restore the BIOS in the future. Copy the original motherboard BIOS using the ASUS Update or AWDFLASH utilities.

Visit the ASUS website and download the latest BIOS file for this motherboard using the ASUS Update utility.

---

### 4.1.1 Creating a bootable floppy disk

1. Do either one of the following to create a bootable floppy disk.

#### DOS environment

Insert a 1.44 MB floppy disk into the drive. At the DOS prompt, type:

```
format A: /S then press <Enter>.
```

#### Windows® 98SE/ME/2000/XP environment

- a. Insert a 1.44 MB floppy disk into the floppy disk drive.
- b. From your Windows desktop, click on **Start**, then select **My Computer**.
- c. Select the **3 1/2 Floppy Drive** icon.
- d. Click **File** from the menu, then select **Format**. A **Format 3 1/2 Floppy Disk** window appears.
- e. If you are using Windows™ XP, select **Create an MS-DOS startup disk** from the format options field, then click **Start**.

OR

If you are using Windows™ 98SE/ME/2000, select **Full** option button from the format type, then click **Start**.

2. Copy the original (or the latest) motherboard BIOS to the bootable floppy disk.

## 4.1.2 AwardBIOS Flash Utility

### Updating BIOS via the Built-in AwardBIOS Flash Utility

The built-in AwardBIOS Flash Utility allows you to easily update the BIOS without having to go through the long process of booting from a floppy disk and using a DOS-based utility. Press <Alt>+<F2> during the Power-On Self Tests (POST) to launch the AwardBIOS flash utility.



---

Write down the BIOS file name to a piece of paper. You need to type the **exact BIOS file name** at the prompt.

---

1. Visit the ASUS website ([www.asus.com](http://www.asus.com)) to download the latest BIOS file for your motherboard and rename it to A7N8X-E.ROM. Save the BIOS file to a floppy disk.
2. Reboot the computer.
3. To use AwardBIOS Flash Utility, press <Alt> + <F2> during POST to display the following screen.

```
AwardBIOS Flash Utility V8.20A
(C)Phoenix Technologies Ltd. All Rights Reserved

For nVidia-nForce-A7N8X      DATE: 08/13/2002
Flash Type - PMC Pm49FL004T LPC/FWH

File Name to Program : aw0702.bin

MacAddr: Safe=0000000000000000

Message: Do You Want To Save Bios (Y/N)
```



---

The BIOS information in the above screen is for reference only. what you see on your screen may not be exactly the same as shown.

---

4. Insert the disk that contains the new BIOS file into the floppy drive. You will receive the error message, "WARNING! Device not ready!" if you proceed to step 5 without the disk in the drive.

5. Type the name of the new BIOS file, for example: "AW0702.BIN" then press <Enter>. The program asks if you want to save the previous BIOS. Select <Y> since it is advisable to back-up the original BIOS in case you need to reprogram it.
6. The program asks to save the previous BIOS to a separate file. Type a file name for the old bios and then press <Y>. The AWDFLASH program backs-up the file.

```
AwardBIOS Flash Utility V8.20A
(C)Phoenix Technologies Ltd. All Rights Reserved

For nVidia-nForce-A7N8X      DATE: 08/13/2002
Flash Type - PMC Pm49FL004T LPC/FWH

File Name to Program : aw0702.bin
Save current BIOS as : old.bin

Message: Press 'Y' to Program or 'N' to Exit
```

7. AWDFLASH proceeds to check the new BIOS file and asks the user to program (flash) the new BIOS file to the motherboard.

```
AwardBIOS Flash Utility V8.20A
(C)Phoenix Technologies Ltd. All Rights Reserved

For nVidia-nForce-A7N8X      DATE: 08/13/2002
Flash Type - PMC Pm49FL004T LPC/FWH

File Name to Program : aw0702.bin
Checksum : DAD6H
Save current BIOS as : old.bin

Message: Press 'Y' to Program or 'N' to Exit
```

8. Type <Y> and Press <Enter> to flash the new Bios file. NOTE: Do not shut off system power or unplug the supply during the flash process.



9. The BIOS flashes and displays the results. Press <F1> to restart.



## Updating BIOS via Bootable Floppy Disk

1. Boot from the floppy disk.
2. At the **A:\** prompt, type **C:\** then press <Enter>.
3. At the **C:\** prompt, type **AWDFLASH /qi BIOSFilename** then <Enter> to display the AWDFLASH screen.
4. Type the name of the new BIOS file, for example: "AW0702.BIN" then press <Enter>. The program prompts if you want to save the previous BIOS. Select <Y> to back-up the original BIOS in case you need to reprogram it.
5. Follow steps 6 to 9 of the "Updating BIOS via the Built-in Award BIOS Flash Utility." section.



## 4.1.3 ASUS Update

The ASUS Update is a utility that allows you to update the motherboard BIOS in Windows® environment. This utility is available in the support CD that comes with the motherboard package. ASUS Update requires an Internet connection either through a network or an Internet Service Provider (ISP).

To install ASUS Update:

1. Insert the support CD into the CD-ROM drive. The **Drivers** menu appears.
2. Click the **Utilities** tab, then click **Install ASUS Update VX.XX.XX**. See page 5-3 for the **Utilities** menu screen.
3. The ASUS Update utility is copied into your system.

To update the BIOS using the ASUS Update:

1. Launch the utility from the Windows desktop by clicking **Start > Programs > ASUS > ASUSUpdate > ASUSUpdate**. The ASUS Update initial screen appears.
2. Select your desired update method, then click **Next**.

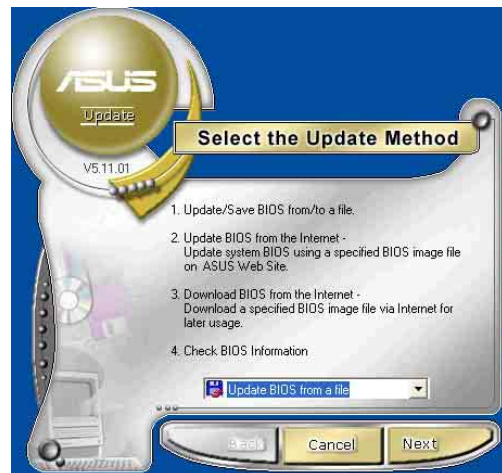

3. If you selected updating/downloading from the Internet, select the ASUS FTP site nearest you to avoid network traffic, or choose **Auto Select**. Click **Next**.

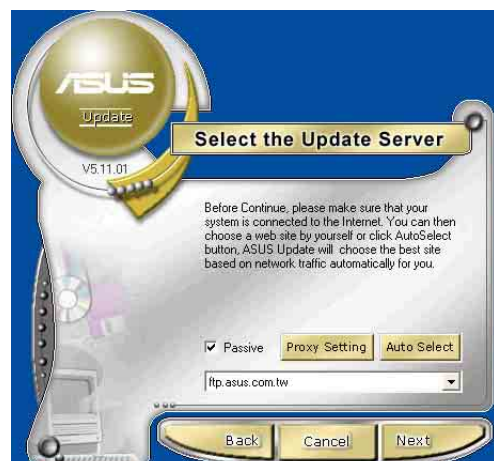

4. From the FTP site, select the BIOS version that you wish to download. Click **Next**.
5. Follow the instructions on the succeeding screens to complete the update process.

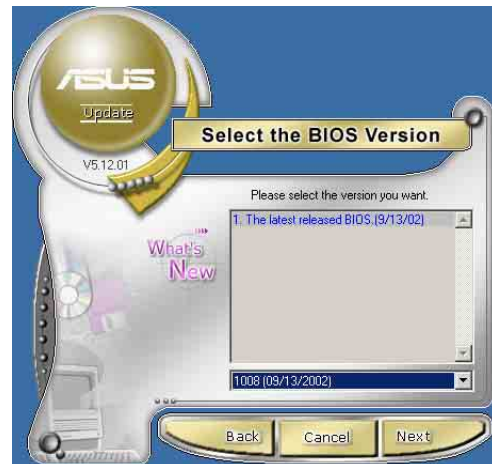

If you selected the option to update the BIOS from a file, a window pops up prompting you to locate the file. Select the file, click **Save**, then follow the screen instructions to complete the update process.



## 4.2 BIOS Setup program

This motherboard supports a programmable firmware chip that you can update using the provided utility described in section “4.1 Managing and updating your BIOS.”

Use the BIOS Setup program when you are installing a motherboard, reconfiguring your system, or prompted to “Run Setup”. This section explains how to configure your system using this utility.

Even if you are not prompted to use the Setup program, you may want to change the configuration of your computer in the future. For example, you may want to enable the security password feature or change the power management settings. This requires you to reconfigure your system using the BIOS Setup program so that the computer can recognize these changes and record them in the CMOS RAM of the firmware hub.

The firmware hub on the motherboard stores the Setup utility. When you start up the computer, the system provides you with the opportunity to run this program. Press <Delete> during the Power-On Self Test (POST) to enter the Setup utility. Otherwise, POST continues with its test routines.

If you wish to enter Setup after POST, restart the system by pressing <Ctrl> + <Alt> + <Delete>, or by pressing the reset button on the system chassis. You can also restart by turning the system off and then back on. Do this last option only if the first two failed.

The Setup program is designed to make it as easy to use as possible. It is a menu-driven program, which means you can scroll through the various sub-menus and make your selections from the available options using the navigation keys.



---

The default BIOS settings for this motherboard apply for most conditions to ensure optimum performance. If the system becomes unstable after changing any BIOS settings, load the default settings to ensure system compatibility and stability. Select the **Load Default Settings** item under the Exit Menu. See section “4.7 Exit Menu.”

---



---

The BIOS setup screens shown in this chapter are for reference purposes only, and may not exactly match what you see on your screen.

Visit the ASUS website ([www.asus.com](http://www.asus.com)) to download the latest product and BIOS information.

---

## 4.2.1 BIOS menu screen

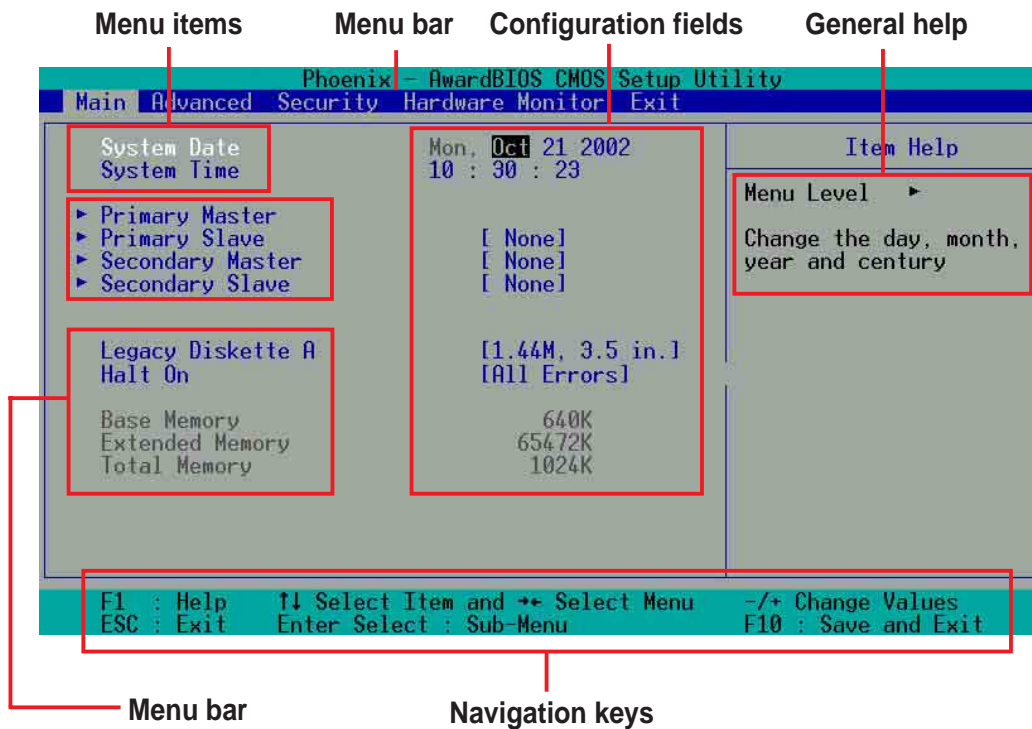

## 4.2.2 Menu bar

The menu bar on top of the screen has the following main items:

- Main** For changing the basic system configuration
- Advanced** For changing the advanced system settings
- Security** Use this menu to set the Supervisor and User passwords.
- Hardware Monitor** Monitor the status of vital components, including voltages and fan speeds.
- Exit** For selecting the exit options and loading default settings

To select an item on the menu bar, press the right or left arrow key on the keyboard until the desired item is highlighted.

## 4.2.3 Navigation keys

At the **bottom right corner** of a menu screen are the navigation keys for that particular menu. Use the navigation keys to select items in the menu and change the settings.



Some of the navigation keys differ from one screen to another.

## 4.2.4 Menu items

The highlighted item on the menu bar displays the specific items for that menu. For example, selecting **Main** shows the Main menu items.

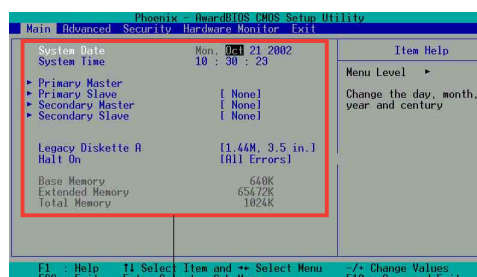

Main menu items

The other items (Advanced, Power, Boot, and Exit) on the menu bar have their respective menu items.

## 4.2.5 Sub-menu items

An item with a sub-menu on any menu screen is distinguished by a solid triangle before the item. To display the sub-menu, select the item and press Enter.

## 4.2.6 Configuration fields

These fields show the values for the menu items. If an item is user-configurable, you may change the value of the field opposite the item. You can not select an item that is not user-configurable.

A configurable field is enclosed in brackets, and is highlighted when selected. To change the value of a field, select it then press Enter to display a list of options. Refer to “4.2.7 Pop-up window.”

## 4.2.7 General help

At the top right corner of the menu screen is a brief description of the selected item.

## 4.2.8 Pop-up window

Select a menu item then press Enter to display a pop-up window with the configuration options for that item.

## 4.2.9 Scroll bar

A scroll bar appears on the right side of a menu screen when there are items that do not fit on the screen. Press **Up/Down arrow keys** or **PageUp/PageDown keys** to display the other items on the screen.

## 4.3 Main menu

When you enter the BIOS Setup program, the Main menu screen appears giving you an overview of the basic system information.



Refer to section “4.2.1 BIOS menu screen” for information on the menu screen items and how to navigate through them.

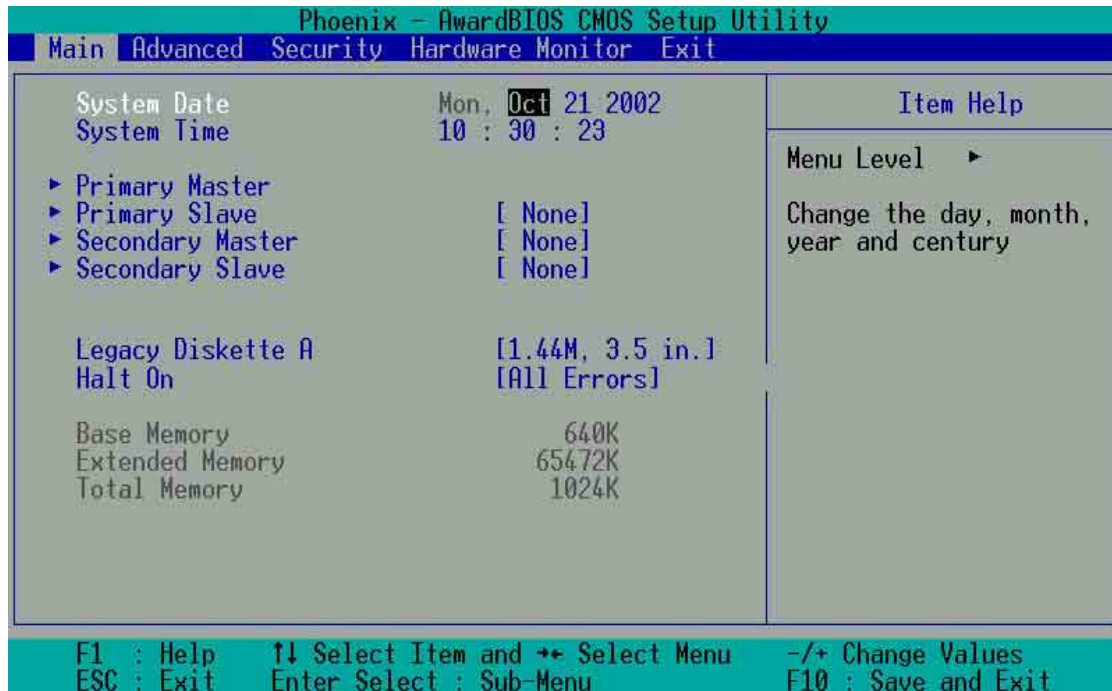

### 4.3.1 System Time [xx:xx:xxxx]

This item allows you to set the system time.

### 4.3.2 System Date [Day xx/xx/xxxx]

This item allows you to set the system date.

### 4.3.3 Legacy Diskette A [1.44M, 3.5 in.]

Sets the type of floppy drive installed. Configuration options: [Disabled] [360K, 5.25 in.] [1.2M , 5.25 in.] [720K , 3.5 in.] [1.44M, 3.5 in.] [2.88M, 3.5in.]

### 4.3.4 Halt On [All Errors]

This field sets the system to halt on errors according to the system functions specified in each option. Configuration options: [All Errors] [No Errors] [All, But Keyboard] [All, But Diskette] [All, But Disk/Key]

## 4.3.5 Primary and Secondary Master/Slave

While entering Setup, BIOS auto-detects the presence of IDE devices. There is a separate sub-menu for each IDE device. Select a device item then press Enter to display the IDE device information.

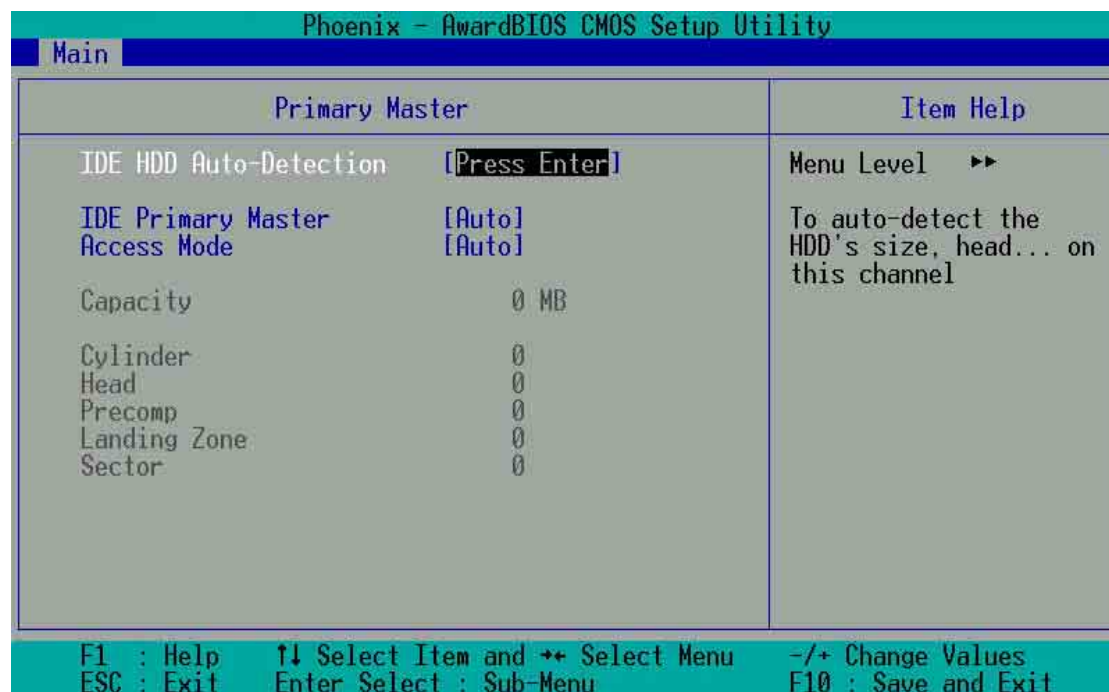

The values opposite the dimmed items (Capacity, Cylinder, Head, PreComp, Landing Zone) are auto-detected by BIOS and are not user-configurable. These items show N/A if no IDE device is installed in the system.

### IDE HDD Auto-Detection [Press Enter]

If there is no IDE hard disk drive displayed on this field, press <Enter> to automatically detect an IDE hard disk drive. In cases of undetected HDDs, pressing enter will detect the HDD and then open access to both the IDE Primary Master and Access Mode fields.

### IDE Primary Master [Auto]

Select [Auto] to automatically detect an IDE hard disk drive. If automatic detection is successful, the setup BIOS automatically fills in the correct values for the remaining fields on this sub-menu. If automatic detection fails, this may be because the hard disk drive is too old or too new. If the hard disk was already formatted on a previous system, the setup BIOS may detect incorrect parameters. In these cases, select [Manual] to manually enter the IDE hard disk drive parameters. If no drive is installed or if you are removing a drive and not replacing it, select [None]. Configuration options: [None] [Auto] [Manual]

## Access Mode [Auto]

The default [Auto] automatically detects an IDE hard disk drive. Select [CHS] in coordination with the [Manual] setting of the **IDE Primary Master** in order to enter the Hard Disk Drive values manually.



Before attempting to configure a hard disk drive, make sure you have the correct configuration information supplied by the drive manufacturer. Incorrect settings may cause the system to fail to recognize the installed hard disk.

## [Manual] & [CHS] Settings

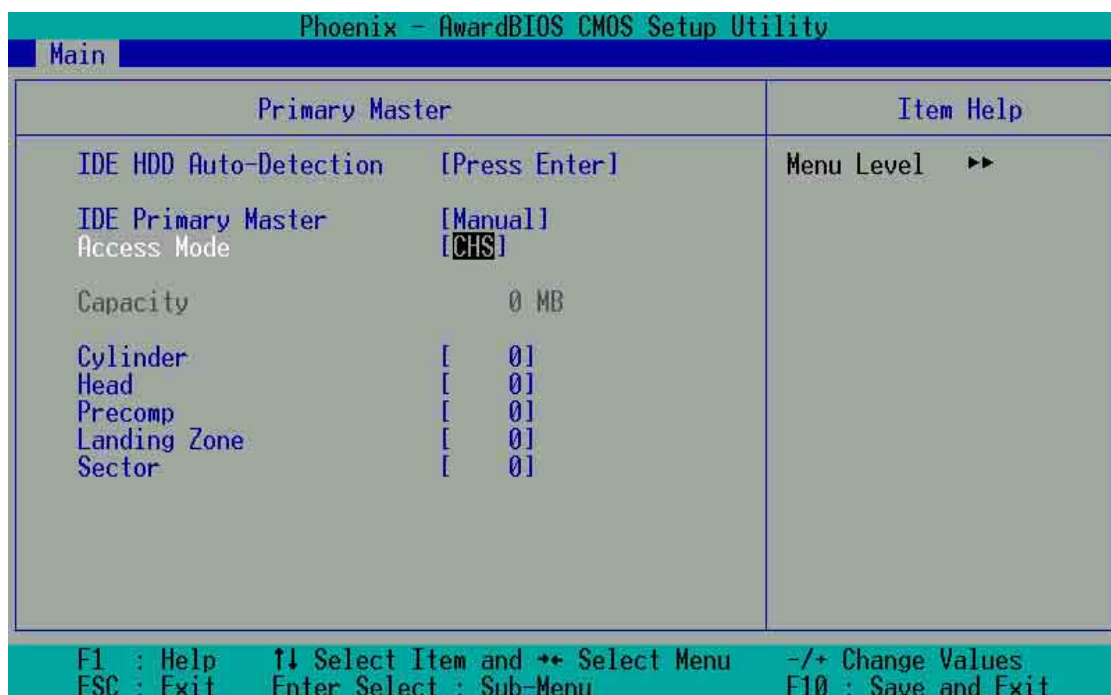

Manually enter the number of cylinders, heads and sectors per track for the drive. Refer to the drive documentation or on the drive label for this information.



After entering the IDE hard disk drive information into BIOS, use a disk utility, such as FDISK, to partition and format new IDE hard disk drives. This is necessary so that you can write or read data from the hard disk. Make sure to set the partition of the Primary IDE hard disk drives to active.

After making your selections on this sub-menu, press the <Esc> key to return to the Main menu. When the Main menu appears, the hard disk drive field displays the size for the hard disk drive that you configured.



### **Access Mode [Auto]**

Select the hard disk drive type in this field. When Logical Block Addressing (LBA) is enabled, the 28-bit addressing of the hard drive is used without regard for cylinders, heads, or sectors. Note that LBA Mode is necessary for drives with more than 504MB storage capacity. Select [CHS] to make manual entries for configuring the fields below. Configuration options: [CHS] [LBA] [Large] [Auto]

### **Cylinders**

This field configures the number of cylinders. Refer to the drive documentation to determine the correct value. To make changes to this field, set the **IDE Primary Master** field to [Manual] and the **Access Mode** to [CHS].

### **Head**

This field configures the number of read/write heads. Refer to the drive documentation to determine the correct value. To make changes to this field, set the **IDE Primary Master** field to [Manual] and the **Access Mode** to [CHS].

### **Precomp**

This field displays the precompressed volumes on the hard disk, if any, in MB.

### **Landing Zone**

This field displays the drive's maximum useable capacity as calculated by the BIOS based on the drive information you entered.

### **Sector**

This field configures the number of sectors per track. Refer to the drive documentation to determine the correct value. To make changes to this field, set the Type field to [User Type HDD] and the **Translation Method** field to [Manual].

## 4.4 Advanced menu

The Advanced menu items allow you to change the settings for the CPU and other system devices.



Take caution when changing the settings of the Advanced menu items. Incorrect field values may cause the system to malfunction.

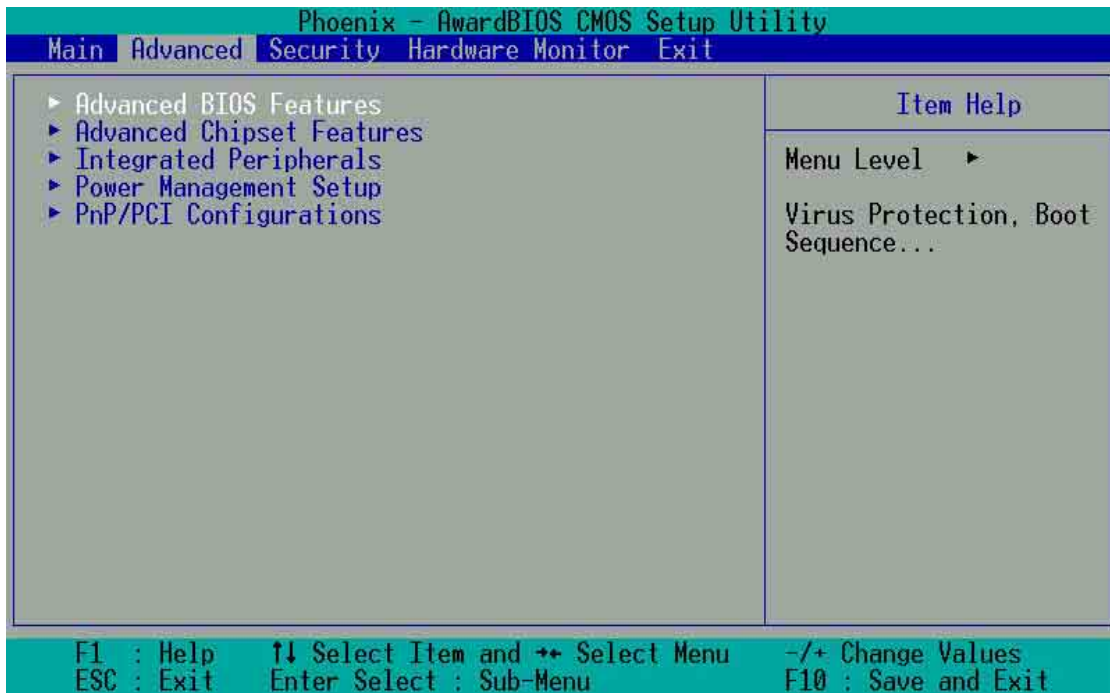

## 4.4.1 Advanced BIOS Features

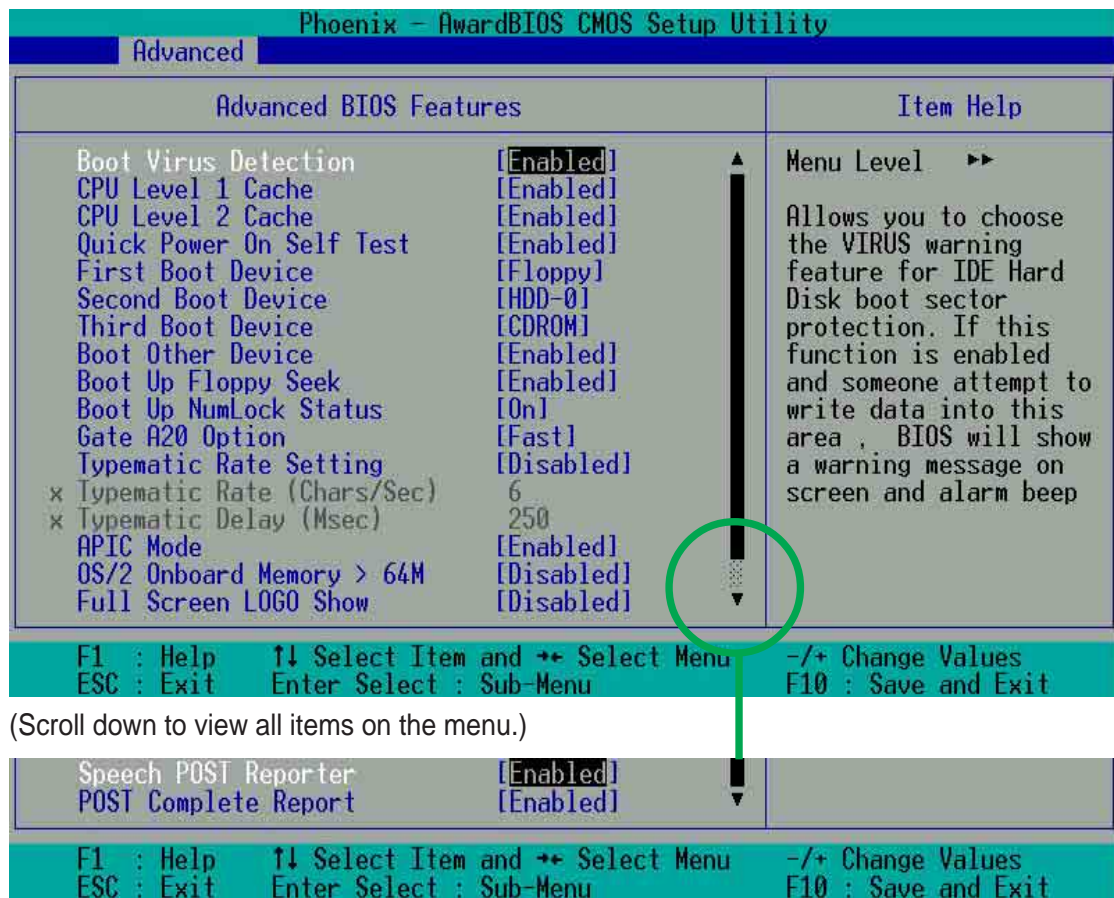

### Boot Virus Detection [Disabled]

This field enables or disables the boot virus protection.  
Configuration options: [Enabled] [Disabled]

### CPU Level 1 Cache [Enabled]

This field enables or disables the CPU level 1 cache.  
Configuration options: [Enabled] [Disabled]

### CPU Level 2 Cache [Enabled]

This field enables or disables the level 2 cache.  
Configuration options: [Enabled] [Disabled]

### Quick Power On Self Test [Enabled]

This field enables or disables the power on test.  
Configuration options: [Enabled] [Disabled]

### **First Boot Device [Floppy]**

This field sets the priority of the first boot device. By default, the system boots up on the floppy diskette drive. Configuration options: [Floppy] [LS120] [HDD-0] [SCSI] [CDROM] [HDD-1] [HDD-2] [HDD-3] [ZIP] [USB-FDD] [USB-ZIP] [USB-CDROM] [USB-HDD] [LAN] [Disabled]

### **Second Boot Device [HDD]**

This field sets the priority of the second boot device. By default, the system boots up on the hard disk driver if the floppy drive is not present. Configuration options: [Floppy] [LS120] [HDD-0] [SCSI] [CDROM] [HDD-1] [HDD-2] [HDD-3] [ZIP] [USB-FDD] [USB-ZIP] [USB-CDROM] [USB-HDD] [LAN] [Disabled]

### **Third Boot Device [CDROM]**

This field sets the priority of the third boot device. By default, the system boots up on the LS120 if the floppy and hard disk drive are not present. Configuration options: [Floppy] [LS120] [HDD-0] [SCSI] [CDROM] [HDD-1] [HDD-2] [HDD-3] [ZIP] [USB-FDD] [USB-ZIP] [USB-CDROM] [USB-HDD] [LAN] [Disabled]

### **Boot Other Device [Enabled]**

By default, this field allows you to boot from other devices, aside from the first three priority devices. Configuration options: [Enabled] [Disabled]

### **Boot Up Floppy Seek [Enabled]**

If enabled, this field speeds up the Power On Self Test (POST) routine by skipping and retesting a second, third and fourth time. Configuration options: [Enabled] [Disabled]

### **Boot Up NumLock Status [On]**

This field sets the capability of the NumLock light/key to display/activate the system. Configuration options: [On] [Off]

### **Gate A20 Option [Fast]**

This field sets the gate A20 rate. The default is [Fast]. Configuration options: [Normal] [Fast]

### **Typematic Rate Setting [Disabled]**

This field enables or disable permission to change the rate of keystroke registration and display. By default, the rate cannot be changed. Change to [Enabled] to make settings in the nextt field. Configuration options: [Enabled] [Disabled]

### **Typematic Rate Setting (Char/Sec) [6]**

This field determines the number of keystrokes per second that the system can register. Configuration options: [6] [8] [10] [12] [15] [20] [24] [30]

### **Typematic Delay (Msec) [250]**

This field determines the delay time ( in milliseconds ) between registering a keystroke and displaying it onscreen. Configuration options: [250] [500] [750] [1000]

### **APIC Mode [Enabled]**

This field enables or disables the APIC mode. Configuration options: [Enabled] [Disabled]

### **OS/2 Onboard Memory > 64MB [Disabled]**

This field enables or disables the 64MB onboard memory set for OS/2. Configuration options: [Disabled] [Enabled]

### **Full Screen LOGO Show [Enabled]**

This field enables or disables display of the full screen logo for environmental protection. Configuration options: [Enabled] [Disabled]

### **Speech POST Reporter [Enabled]**

This field enables or disables the ASUS POST Reporter™ feature. Configuration options: [Enabled] [Disabled]

### **POST Complete Report [Enabled]**

This field enables or disables display of the Power On Self Test (POST) complete report. Configuration options: [Enabled] [Disabled]

## 4.4.2 Advanced Chipset Features

The Chipset menu items allow you to change the advanced chipset settings. Select an item then press Enter to display the sub-menu.

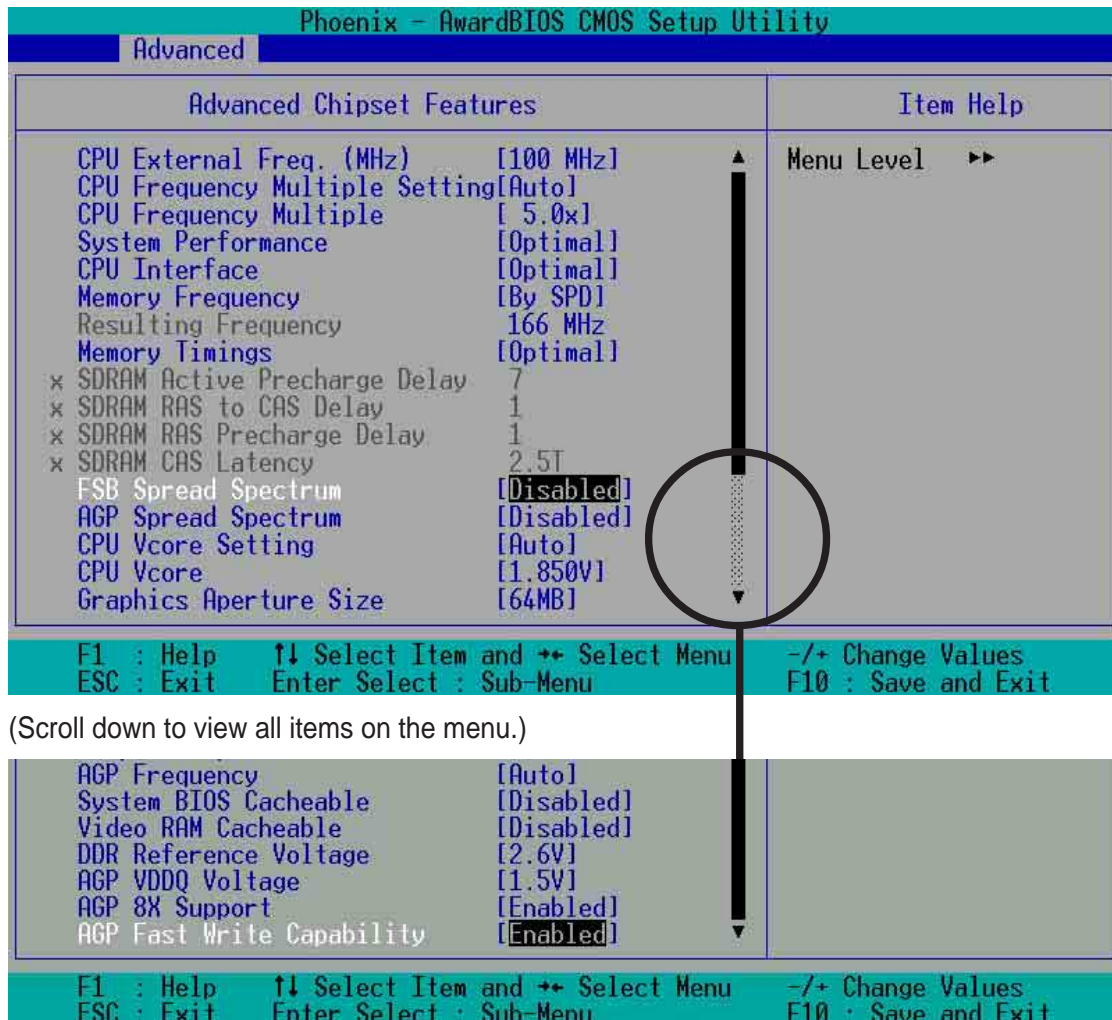

### CPU External Frequency (MHz) [100MHz]

This field sets the external frequency ratio of the CPU. The system normally auto-detects the frequency capability based on the type of CPU installed. The Front Side Bus (FSB) is equal to 2 times this field value. Frequency ranges are adjustable in increments of 1, 2, 3 and/or 5 MHz. Configuration options: [100 MHz]... [200 MHz] [204 MHz] [207 MHz] [211 MHz] [300 MHz]

### CPU Frequency Multiple Setting [Auto]

This field sets the frequency multiple between the CPU's internal frequency (CPU speed) and external frequency. Set this field in conjunction with CPU Frequency (MHz) to match the speed of the CPU.

## **CPU Frequency Multiple [5.0x]**

This field is available to unlocked processors only. For unlocked processors, this field sets the frequency multiple between the CPU's internal frequency (CPU speed) and the external frequency.

## **System Performance [Optimal]**

This field permits change of mode for system performance. When set to [Optimal], the system uses the most stable settings. When you want to use overclocked settings for higher performance but with higher risk of instability, set to [Aggressive] and to allow full customization of performance options set to [User Defined]. Configuration options: [Optimal] [Aggressive] [User Defined]

## **CPU Interface [Optimal]**

This field sets the mode for CPU/FSB parameters usage. Select [Aggressive] if you want to use overclocked CPU/FSB parameters. Otherwise, the default value is [Optimal] where it uses the most stable CPU/FSB parameters. Configuration options: [Optimal] [Aggressive]

## **Memory Frequency [By SPD]**

This field sets the type of memory frequency based on the type of DDR (Double Data Rate) memory module installed. Resulting frequency can vary depending on percentage setting which is multiplied by the FSB frequency. Normally, the default, by SPD, permits autodetection. Configuration options: [By SPD] [50%] [60%] [66%] [75%] [80%] [83%] [Sync] [120%] [125%] [133%] [150%] [166%] [200%]

## **Resulting Frequency**

This field displays the detected memory frequency

## **Memory Timing [Optimal]**

This field permits change of memory timing mode for system performance. When set to [User Defined], the next four fields can be set manually. Set to [Aggressive] for higher performance. Use default [Optimal] to use most stable settings. Configuration options: [Optimal] [Aggressive] [User Defined]

## **SDRAM Active Precharge Delay [7]**

Row-active delay.

### **SDRAM RAS to CAS Delay [3]**

RAS-to-CAS. This item controls the latency between the SDRAM Active command to the SDRAM.

### **SDRAM RAS Precharge Delay [3]**

This item controls the idle clocks after issuing a precharge command to the DDR SDRAM.

### **SDRAM CAS Latency [2.5T]**

This field sets the override clock cycle for the latency time between the SDRAM read command and the moment that the data actually becomes available. Normally, the system determines the rate automatically by default.

### **FSB Spread Spectrum [0.50%]**

Configuration options: [Disabled] [0.50%] [1.00%]

### **AGP Spread Spectrum [Disabled]**

Configuration options: [Disabled] [0.50%]

### **CPU Vcore Setting [Auto]**

This field determines if the CPU  $V_{\text{CORE}}$  is automatically scaled or set manually by the user. The default for this field is [Auto], therefore, the CPU  $V_{\text{CORE}}$  voltage is set for maximum performance without stressing the CPU. Configuration options: [Auto] [Menu]

### **CPU Vcore [1.850V]**

When the CPU  $V_{\text{CORE}}$  Setting parameter is set to [Manual], this field permits selection of specific CPU core voltages. This field is not accessible if the above **CPU VCore Setting** parameter is set to [Auto]. Configuration options: [1.100V] [1.125V] ... [1.825] [1.850V]

### **Graphics Aperture Size [64M]**

This field sets the size of mapped memory ( in megabytes ) for AGP graphic data. Configuration options: [32M] [64M] [128M] [256M] [512M]

### **AGP Frequency [Auto]**

This field sets the frequency of the AGP controller. The default, [Auto], permits automatic selection of optimal AGP frequencies. Configuration options: [50, 66, 67, 68, 69, 70, 71, 72, 73, 74, 75, 76, 77, 78, 79, 80, 81, 82, 83, 84, 85, 86, 87, 90, 93, 95, 97, 100MHz]



### **System BIOS Cacheable [Disabled]**

This field establishes whether or not the BIOS is cacheable. Disabled by default. Configuration options: [Enabled] [Disabled]

### **Video RAM Cacheable [Disabled]**

This field establishes whether or not the video RAM is cacheable. Disabled by default. Configuration options: [Enabled] [Disabled]

### **DDR Reference Voltage [ 2.6V]**

This field sets the voltage limits for the voltage supplied to the DDR memory. Note that increasing voltage to the DDR can cause premature failure of system components. Configuration options: [2.6V] [2.7V] [2.8V]

### **AGP VDDQ Voltage [1.5V]**

This field sets the voltage limits for the voltage supplied to the AGP controller. Note that increasing voltage to the AGP controller can cause premature failure of system components. Configuration options: [1.5V] [1.6V] [1.7V]

### **AGP 8X Support [Enabled]**

This field enables or disables the AGP 8X support. Configuration options: [Disable] [Enable]

### **AGP Fast Write Capability [Enabled]**

This field enables or disables the AGP Fastwrite function. Configuration options: [Disable] [Enable]

## 4.4.3 Integrated Peripherals

Phoenix - AwardBIOS CMOS Setup Utility		
Advanced		
Integrated Peripherals	Item Help	
Primary VGA BIOS	[PCI VGA Card]	Menu Level ▶▶
USB Controllers	[V1.1+V2.0]	
USB Keyboard & Legacy Support	[Enabled]	
USB Legacy Mouse Support	[Disabled]	
Onboard AC97 Audio Controller	[Auto]	
Onboard Lan(nVIDIA)	[Auto]	
Onboard 1394 Device	[Auto]	
Floppy Disk Access Controller	[Enabled]	
Onboard Serial Port 1	[3F8/IRQ4]	
Onboard Serial Port 2	[2F8/IRQ3]	
UART2 use as	[COM Port]	
Onboard Parallel Port	[378/IRQ7]	
Parallel Port Mode	[ECP+EPP]	
ECP DMA Select	[3]	
Onboard Game Port	[201]	
Onboard MIDI I/O	[330]	
Onboard MIDI IRQ	[10]	

F1 : Help    ↑↓ Select Item and →← Select Menu    -/+ Change Values  
ESC : Exit    Enter Select : Sub-Menu    F10 : Save and Exit

### Primary VGA BIOS [PCI VGA Card]

This field sets the priority for the display of VGA signals. Change from the PCI VGA Cardt default to AGP VGA Card if using an AGP card.

Configuration options: [PCI VGA Card] [AGP VGA Card]

### USB Controllers [V1.1+V2.0]

This field sets the protocols for OnChip processing of USB outputs. The default accomodates USB protocols 1.0 and 2.0. Configuration options: [Disabled] [V1.1 +V2.0] [V1.1]

### USB Keyboard and Legacy Support [Enabled]

This field sets support for USB keyboards. The USB keyboard is disabled by default. Enable this field to use a USB keyboard. Configuration options: [Enabled] [Disabled]

### USB Legacy Mouse Support [Disabled]

This field sets support for USB legacy mouse. The USB legacy mouse is disabled by default. Enable this field to use a USB legacy mouse. Configuration options: [Enabled] [Disabled]

### Onboard AC97 Audio Controller [Auto]

This field permits auto selection of AC97 audio codec processing by default. Configuration options: [Auto] [Disabled]

### Onboard Lan (nVIDIA) [Auto]

This field permits auto selection of MAC Lan (nVidia) support by default. Configuration options: [Auto] [Disabled]

### **Onboard 1394 Device [Auto]**

When set to auto, this field sets the on chip support for IEEE 1394 signal outputs. Configuration options: [Auto] [Disabled]

### **Floppy Disk Access Controller [Enabled]**

This field enables the FDA Controller.

Configuration options: [Enabled] [Disabled]

### **Onboard Serial Port 1 [3F8/IRQ4]**

These fields set the addresses for onboard serial port 1. Serial Port 1 and Serial Port 2 must have different addresses. Configuration options:

[Disabled] [3F8/IRQ4] [2F8/IRQ3] [3E8/IRQ4] [2E8/IRQ3] [Auto]

### **Onboard Serial Port 2 [2F8/IRQ3]**

These fields set the addresses for onboard serial port 2. Serial Port 1 and Serial Port 2 must have different addresses. Configuration options:

[Disabled] [3F8/IRQ4] [2F8/IRQ3] [3E8/IRQ4] [2E8/IRQ3] [Auto]

### **UART use as [COM Port]**

This field selects the device assignment for UART2 mode. The default is [COM Port]. Select [IR] to activate the next field, "UR2 Duplex Mode".

Configuration options: [IR] [COM Port]

### **Onboard Parallel Port [378/IRQ7]**

This field sets the address of the onboard parallel port connector to 378/IRQ7 by default. Disabling the port makes the parallel port unavailable.

Configuration options: [Disabled] [378/IRQ7] [278/IRQ5] [3BC/IRQ7]

### **Parallel Port Mode [ECP+EPP]**

This field sets the operation mode of the parallel port. The default, SPP, enables normal-speed operation but in one direction only; EPP enables bidirectional parallel port operation; ECP enables the parallel port to operate in bidirectional DMA mode; ECP+EPP enables normal speed operation in a both ECP and EPP modes. Select [ECP] to access the next field, "ECP Mode Use DMA". Configuration options: [SPP] [EPP] [ECP] [ECP +EPP]

### **ECP DMA Select [3]**

This field sets the parallel port DMA channel for the selected ECP mode. The default setting is 3. This selection is available only if you select [ECP] or [ECP+EPP] in Parallel Port Mode above. Configuration options: [1] [3]

### Onboard Game Port [201]

This field sets the address of the game port to 201 by default. Disabling the game port makes the port unavailable.

Configuration options: [Disabled] [201] [209]

### Onboard MIDI I/O [330]

This field sets the address of the MIDI I/O port to 330 by default.

Configuration options: [Disabled] [330] [300]

### Onboard MIDI IRQ [10]

This field sets the IRQ address of the MIDI port to 10 by default.

Configuration options: [5] [10]

## 4.4.4 Power Management Setup

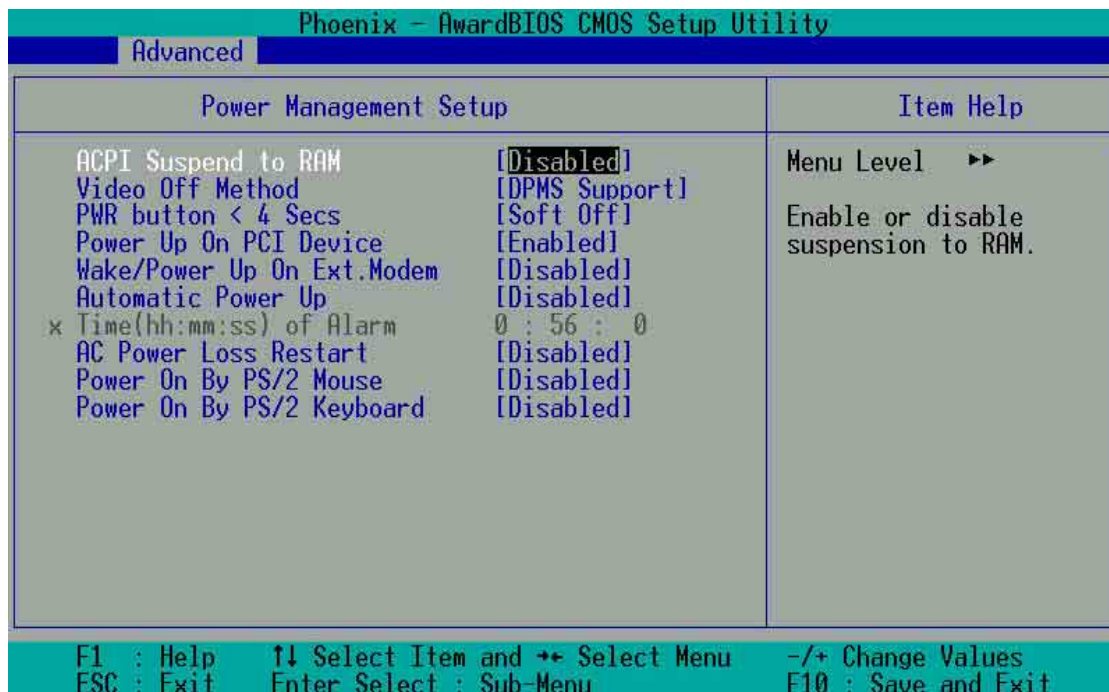

### ACPI Suspend to RAM [Disabled]

This field enables or disables suspension to RAM. Configuration options: [Enabled] [Disabled]

### Video Off Method [DPMS Support]

This field defines “video off” features. The DPMS support option (Display Power Management System) permits the BIOS to control the video display card if it supports the DPMS feature. Blank Screen option blanks the screen; use blank screen for monitors without power management or “green” features. [V/H SYNC+Blank] blanks the screen and turns off vertical and horizontal scanning. Configuration options: [Blank Screen] [V/H SYNC+Blank] [DPMS Support]

### **PWR button < 4 Secs [Soft-Off]**

This field sets the delay after which the system powers off after depressing the external case-mounted power button. The default setting powers off the system instantly. Configuration options: [Soft-Off] [Suspend]

### **Power Up on PCI Device [Disabled]**

This field enables Wake-On-LAN from soft-off mode. The default disables this option. Configuration options: [Enabled] [Disabled]

### **Wake-Power Up On Ext. Modem [Disabled]**

This field allows either settings of [Enabled] or [Disabled] for powering up the computer when the external modem receives a call while the computer is in Soft-off mode. Configuration options: [Enabled] [Disabled]

### **Automatic Power Up [Disabled]**

This field sets to enable or disable the automatic power up. When [Enabled] the **Time (hh:mm:ss) of Alarm** field is enabled for input. Configuration options: [Enabled] [Disabled]

### **Time (hh:mm:ss) of Alarm 0:00:00**

This field sets the time for automatic power up. Enter the hour, minute and second based on the 24 hour clock. The Automatic Power Up field must be enabled to use this feature.

### **AC Power Loss Restart [Disabled]**

This allows you to set whether or not to reboot the system after power interruptions. [Disabled] leaves your system off while [Enabled] reboots the system. [Previous State] sets the system back to the state it was before the power interruption. Configuration options: [Disabled] [Enabled] [Previous State]

### **Power On By PS/2 Mouse [Disabled]**

When set to [Enabled], this parameter allows you to use the PS/2 mouse to turn on the system. This feature requires an ATX power supply that provides at least 1A on the +5VSB lead. Configuration options: [Disabled] [Enabled]

### **Power On By PS/2 Keyboard [Disabled]**

This parameter allows you to use specific keys on the keyboard to turn on the system. This feature requires an ATX power supply that provides at least 1A on the +5VSB lead. Configuration options: [Disabled] [Any KEY] [Power Key]

## 4.4.5 PnP/PCI Configurations

Phoenix - AwardBIOS CMOS Setup Utility	
Advanced	
PnP/PCI Configurations	Item Help
Resources Controlled By [Auto(ESCD)] x IRQ Resources	Menu Level ▶▶
PCI/VGA Palette Snoop [Disabled]	Default is Disabled. Select Enabled to reset Extended System Configuration Data (ESCD) when you exit Setup if you have installed a new add-on and the system reconfiguration has caused such a serious conflict that the OS cannot boot

F1 : Help    ↑↓ Select Item and →+ Select Menu    -/+ Change Values  
ESC : Exit    Enter Select : Sub-Menu    F10 : Save and Exit

### Resources Controlled By [Auto(ESCD)]

This field sets control over the IRQ resources by the automatic (ESCD) system or manual assignment of IRQ channels. The default enables automatic (ESCD) control. Configuration options: [Auto(ESCD)] [Manual]



Selecting Manual access the IRQ Resources sub-menu; see the next page.

### PCI/VGA Palette Snoop [Disabled]

This field enables the PCI/VGA palette snoop. This feature is disabled by default. Configuration options: [Enabled] [Disabled]

## 4.5 Security Menu

The BIOS Setup program permits two different passwords to control access to the BIOS during system startup: a Supervisor password and a User password. Passwords are not case sensitive, meaning, passwords can be typed in either uppercase or lowercase letters. The table below describes the authority level when setting Supervisor or User Password.

**Table 1: Supervisor/User Set Password**

Security Option	Supervisor Password	User Password
System	<ul style="list-style-type: none"> <li>A password is required when booting and to access the BIOS setup.</li> <li>All items can be modified.</li> </ul>	<ul style="list-style-type: none"> <li>A password is required when booting and to access the BIOS setup.</li> <li>Only the <b>Date and Time</b> fields can be modified.</li> </ul>
System	<ul style="list-style-type: none"> <li>A password is required to access the BIOS setup.</li> <li>All items can be modified.</li> </ul>	<ul style="list-style-type: none"> <li>A password is required to access the BIOS setup.</li> <li>Only the <b>Date and Time</b> fields can be modified.</li> </ul>

**Table 2: User Set Password only**

Security Option	Supervisor Password	User Password
System	None	<ul style="list-style-type: none"> <li>A password is required when booting and to access the BIOS setup.</li> <li>All items can be modified.</li> </ul>
System	None	<ul style="list-style-type: none"> <li>A password is required to access the BIOS setup.</li> <li>All items can be modified.</li> </ul>

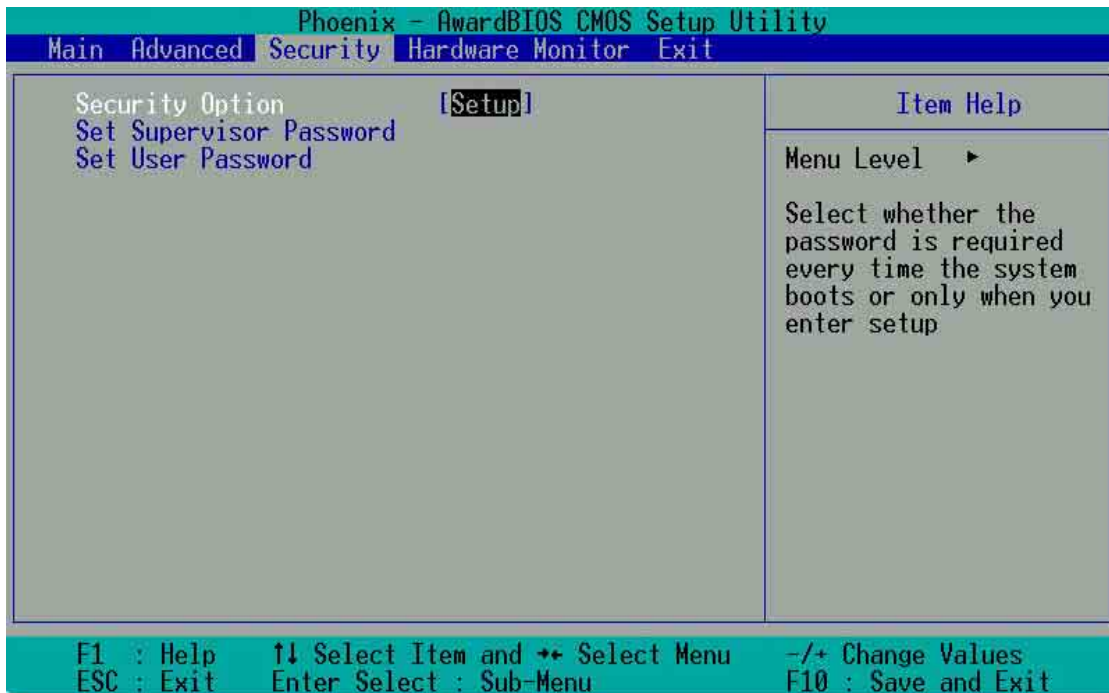

## Security Option [Setup]

This field sets the security options. The default enables the setup option for security. Configuration options: [Setup] [System]

## Set Supervisor Password / Set User Password

To set a password, highlight the appropriate field and press <Enter>. Type in a password then press <Enter>. You can type up to eight alphanumeric characters; symbols and other characters are not useable. To confirm the password, type the password again and press <Enter>. The password is now set to [Enabled]. This password permits full access to the BIOS Setup menus. To clear the password, highlight this field and press <Enter>. The same dialog box as above appears. Press <Enter>. The password is set to [Disabled].

### Forgot the password?

If you forget a password, you can clear it by erasing the CMOS Real Time Clock (RTC) RAM. The RAM data containing the password information is powered by the onboard button cell battery.



See section “2.7 Jumpers” for more information about how to erase the RTC RAM.



## 4.6 Hardware Monitor Menu

The Hardware Monitor menu displays all vital system statistics.

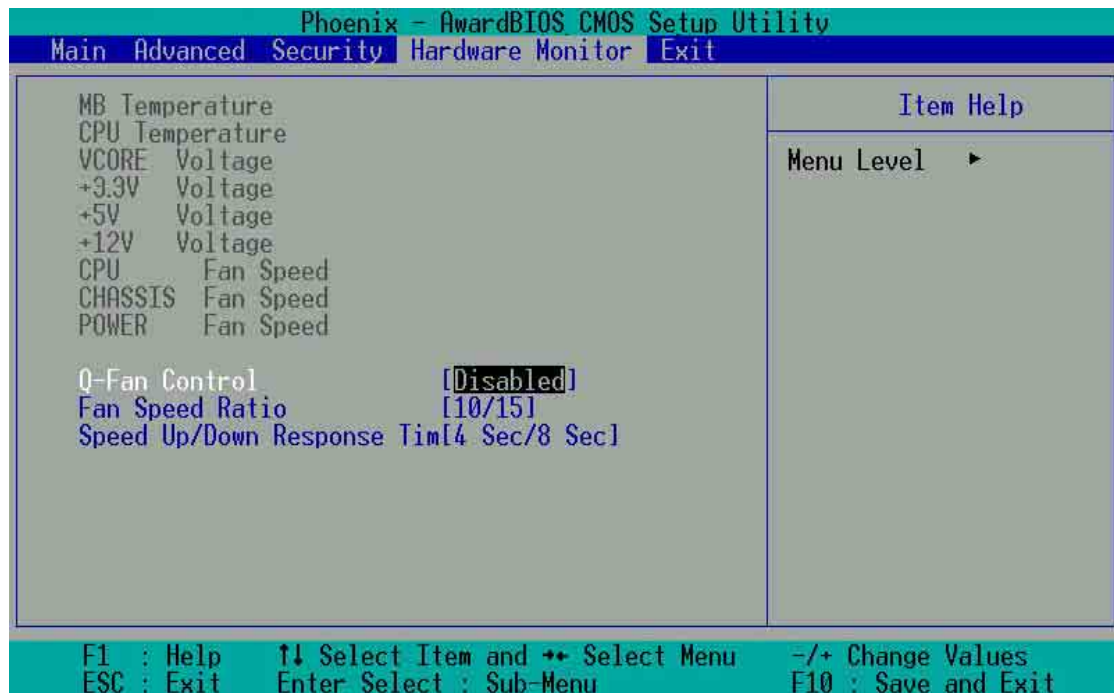

### MB, CPU Temperature [xx C / xx F]

The onboard hardware monitor automatically detects the MB (motherboard) and CPU temperatures.

### VCORE Voltage, +3.3V Voltage, +5V Voltage, +12V Voltage

The onboard hardware monitor automatically detects the voltage output through the voltage regulators.

### CPU Fan Speed xxxx RPM or 0 RPM

### CHASSIS Fan Speed xxxx RPM or 0 RPM

### POWER Fan Speed xxxx RPM or 0 RPM

The onboard hardware monitor automatically detects the CPU, power and chassis fan speeds and displays the fan speeds in revolutions per minute (RPM). If any of the fans is not connected to the fan connectors on the motherboard, the specific field will show N/A.

### Q-Fan Control [Disabled]

This field allows you to enable or disable the ASUS Q-Fan feature that smartly adjusts the fan speeds for more efficient system operation. When this field is set to [Enabled], set the appropriate **Fan Speed Ratio** and **Speed Up/Down Response Time**. Configuration options: [Disabled] [Enabled]

## Fan Speed Ratio [10/15]

This item allows you to select the appropriate fan speed ratio for the system. The default [10/15] is the minimum fan speed ratio. Select a higher ratio if you installed additional devices and the system requires more ventilation. This item is required to be set when the Q-Fan Control field is [Enabled]. Configuration options: [10/15] [11/15] [12/15] [13/15] [14/15] [Full Speed].

## Speed Up/Down Response Time [4 Sec/8 Sec]

This item indicates the time period before the fan speeds adjust to the value set in the **Fan Speed Ratio** field. This item is required to be set when the Q-Fan Control field is [Enabled]. Configuration options: [1 Sec/2 Sec] [2 Sec/4 Sec] [3 Sec/6 Sec] [4 Sec/8 Sec]

## 4.7 Exit Menu

After making all selections from the various menus in the Setup program, save the changes and exit Setup.

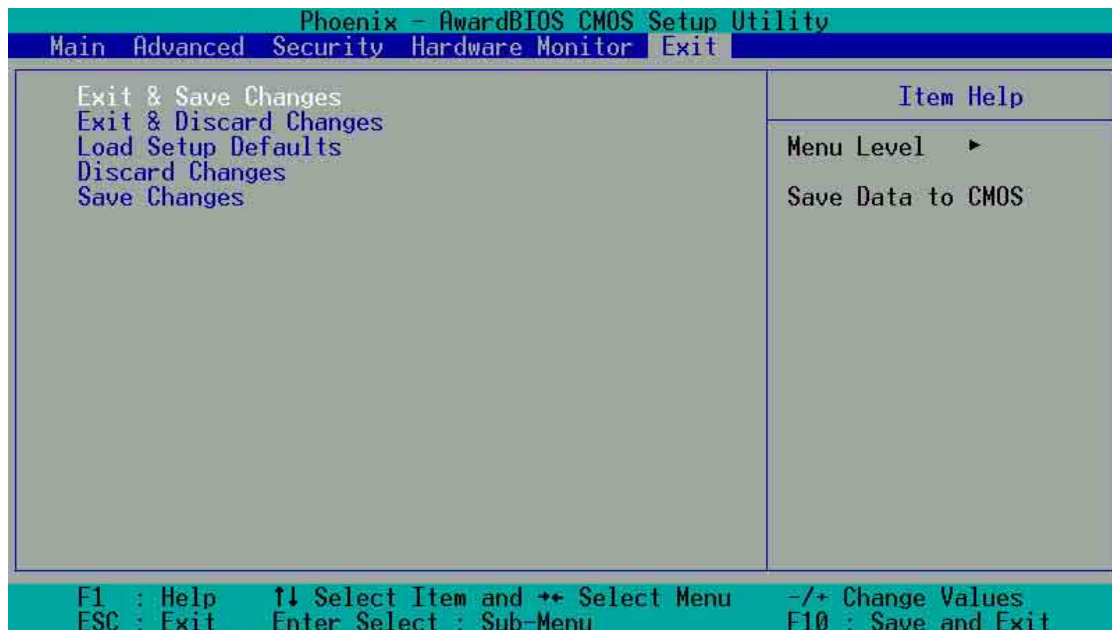

Pressing <Esc> does not immediately exit this menu. Select one of the options from this menu or <F10> from the legend bar to exit.

## Exit & Save Changes

Once you are finished making your selections, choose this option from the Exit menu to ensure the values you selected are saved to the CMOS RAM. The CMOS RAM is sustained by an onboard backup battery and stays on even when the PC is turned off. When you select this option, a confirmation window appears. Select [Yes] to save changes and exit.



---

If you attempt to exit the Setup program without saving your changes, the program prompts you with a message asking if you want to save your changes before exiting. Pressing <Enter> saves the changes while exiting.

---

## Exit & Discard Changes

Select this option only if you do not want to save the changes that you made to the Setup program. If you made changes to fields other than system date, system time, and password, the BIOS asks for a confirmation before exiting.

## Load Setup Defaults

This option allows you to load the default values for each of the parameters on the Setup menus. When you select this option or if you press <F5>, a confirmation window appears. Select [Yes] to load default values. Select Exit Saving Changes or make other changes before saving the values to the non-volatile RAM.

## Discard Changes

This option allows you to discard the selections you made and restore the previously saved values. After selecting this option, a confirmation appears. Select [Yes] to discard any changes and load the previously saved values.

## Save Changes

This option saves your selections without exiting the Setup program. You can then return to other menus and make further changes. After you select this option, a confirmation window appears. Select [Yes] to save any changes to the non-volatile RAM.



# ***Chapter 5***

This chapter describes the contents of the support CD that comes with the motherboard package.

## **Software support**

## **Chapter summary**

- 5.1 Install an operating system ..... 5-1**
- 5.2 Support CD information ..... 5-1**
- 5.3 NVIDIA® nForce control panel ..... 5-3**
- 5.4 NVIDIA® NVSwap 1.0 Utility ..... 5-11**
- 5.5 RAID 0 / RAID 1 configurations ..... 5-13**
- 5.6 Onboard Marvell Gigabit LAN drivers for  
Windows® 98SE/ME ..... 5-16**
- 5.7 Marvell® Virtual Cable Tester Technology .. 5-17**

## 5.1 Install an operating system

This motherboard supports Windows 2000/XP operating system (OS). Always install the latest OS version and corresponding updates so you can maximize the features of your hardware.



---

Because motherboard settings and hardware options vary, use the setup procedures presented in this chapter for general reference only. Refer to your OS documentation for more information.

---

## 5.2 Support CD information

The support CD that came with the motherboard contains useful software and several utility drivers that enhance the motherboard features.



---

The contents of the support CD are subject to change at any time without notice. Visit the ASUS website for updates.

---

### 5.2.1 Running the support CD

To begin using the support CD, simply insert the CD into your CD-ROM drive. The CD automatically displays the **Drivers** menu if Autorun is enabled in your computer.

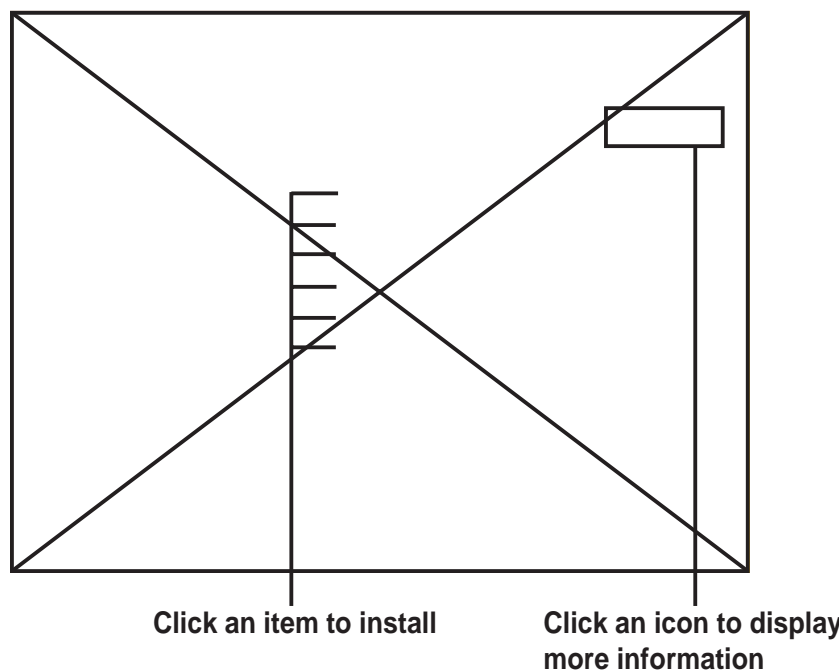

---

If **Autorun** is NOT enabled in your computer, browse the contents of the support CD to locate the file **ASSETUP.EXE** from the BIN folder. Double-click the **ASSETUP.EXE** to run the CD.

---

## 5.2.2 Drivers menu

The drivers menu shows the available device drivers if the system detects installed devices. Install the necessary drivers to activate the devices.

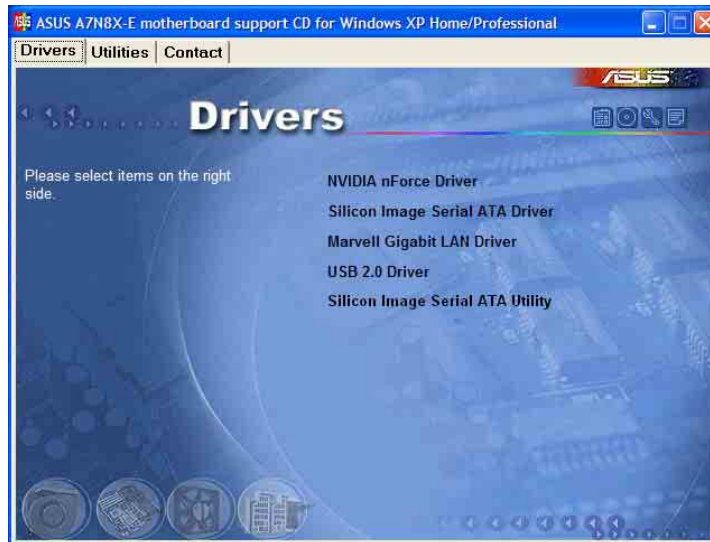

### NVIDIA nForce driver

This item installs the NVIDIA® nForce2 drivers.

### Silicon Image Serial ATA driver

This item displays the step-by-step installation information of the Silicon Image Serial ATA driver for various operating systems.

### Marvell Gigabit LAN Driver

This item installs the Marvell® Gigabit LAN driver for gigabit LAN solution that provides up to 1000Mbps data transfer rates.

### USB 2.0 Driver

This item installs the USB 2.0 driver to upgrade your USB 1.1 ports to USB 2.0.

### Silicon Image Serial ATA Utility

This item installs the software utility to monitor.



- 
- A. For Windows 98SE users, perform the following steps before installing the **NVIDIA nForce Drivers** from support CD.
1. Create a new directory in your root directory (**C:\**) and name it **Win98SRC**.
  2. Copy all the files (excluding sub-directories) from the **Win98** folder of your Windows 98SE CD to the **C:\Win98SRC** folder.
-



- 
3. When you install the **NVIDIA nForce Drivers**, the system will ask for the **Windows 98SE CD**, set the directory to **C:\Win98SRC**.
- B. For Windows 98SE and Windows ME users, following these steps before installing the **Silicon Image Serial ATA Utility**. If you are not using Serial ATA devices, **DO NOT** install the **Silicon Image Serial ATA Utility** or your system may become unstable.
1. Connect the Serial ATA device.
  2. Install Silicon Image Serial ATA Utility from support CD.
  3. If you need to remove or disconnect any Serial ATA device, **UNINSTALL** the **Silicon Image Serial ATA Utility** first.
- 

## 5.2.3 Utilities menu

The Utilities menu shows the applications and other software that the motherboard supports.

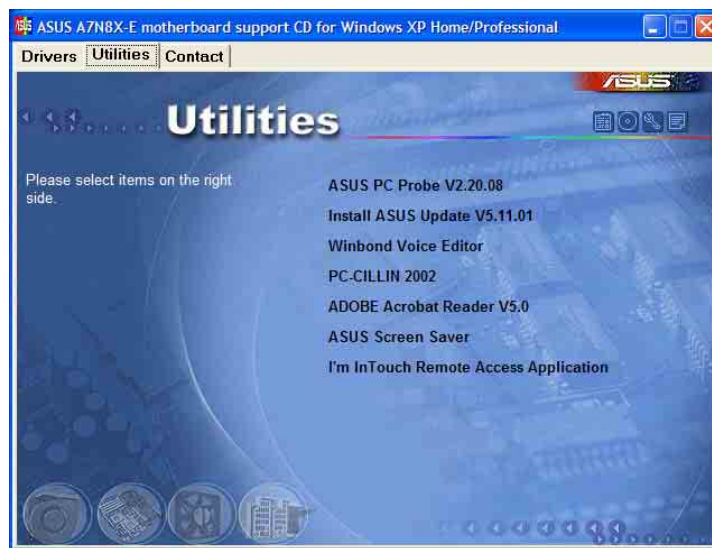

### ASUS PC Probe

This smart utility monitors the fan speed, CPU temperature, and system voltages, and alerts you on any detected problems. This utility helps you keep your computer at a healthy operating condition.

### ASUS Update

This program allows you to download the latest version of the BIOS from the ASUS website. See section “4.1.3 ASUS Update” on page 4-5.



---

Before using the ASUS Update, make sure that you have an Internet connection so you can connect to the ASUS website.

---

## Winbond Voice Editor

This program is for recording and customizing wave files for the ASUS POST Reporter™. Use this program if you wish to change the default vocal POST messages. See section “3.3 ASUS POST Reporter™”.

## PC-CILLIN 2002

This item installs the PC-cillin 2002 anti-virus program. View the PC-cillin online help for detailed information.

## Adobe Acrobat Reader V5.0

This item installs the Adobe Acrobat Reader V5.0. The Acrobat Reader software is for viewing files saved in Portable Document Format (PDF).

## ASUS Screen Saver

This item installs the ASUS screen saver.



---

Screen display and utilities option may not be the same for other operating system versions.

---

## I'm InTouch Remote Access Application

This item installs the I'm InTouch Remote Access application that allow users to remotely access files or control some hardware from their PC at home or in the office.

## 5.2.4 ASUS Contact Information

Clicking the ASUS Contact Information tab displays as stated. You may also find this information in the inside front cover of this user guide.



## 5.2.5 Other information

The icons on the top right corner of the screen give additional information on the motherboard and the contents of the support CD. Click an icon to display the specified information.

### Motherboard Info

The window displays the general specifications of the A7N8X-E Deluxe motherboard.

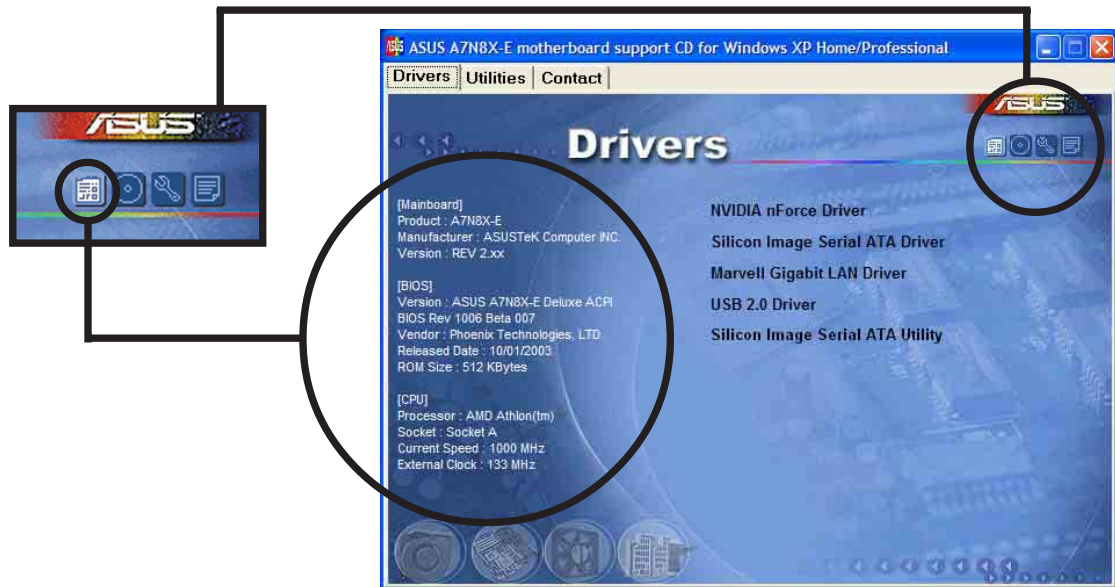

### Browse this CD

The window displays the support CD contents in graphical format.

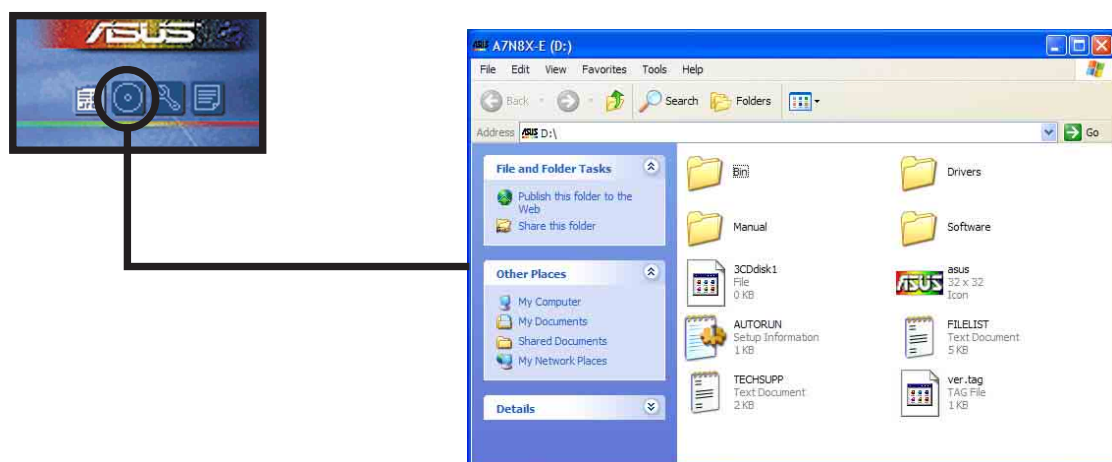

## Technical Support Form

The window displays the ASUS Technical Support Request Form that you have to fill up when requesting technical support.



TECHSUPP - Notepad

ASUSTeK TECHNICAL SUPPORT REQUEST FORM DATE:

ORIGINATOR DESCRIPTION

-----

COMPANY NAME : CONTACT NAME:  
PHONE (AREA) : FAX # (AREA):  
EMAIL ADDRESS:

-----

HARDWARE DESCRIPTION

-----

MOTHERBOARD : REVISION #: BIOS:#401A  
CPU BRAND : SPEED(MHZ):  
DRAM BRAND : SPEED(ns) : SIZE(MB):  
CACHE BRAND : SPEED(ns) : SIZE(KB):  
HARD DISK : MODEL NAME: SIZE(MB):  
CDROM BRAND : MODEL NAME:  
BACKUP BRAND : MODEL NAME: SIZE(MB):  
OTHER STORAGE: MODEL NAME: SIZE(MB):

-----

ADD-IN CARD DESCRIPTION (MODEL NAME/VENDOR)

-----

(E)ISA SLOT 1:  
(E)ISA SLOT 2:  
(E)ISA SLOT 3:  
(E)ISA SLOT 4:

## Filelist

The window displays the contents of the support CD and a brief description of each in text format.



FILELIST - Notepad

File list for the included support software for NVIDIA nForce2 series motherboard

File Name	Description
--Drivers	
-All-in-one	-NVIDIA nForce all in one Drivers
-9X	-NVIDIA nForce all in one Drivers for win98 package version 2.64 and 3.62 audio driver/3.63 LAN driver.
-ME	-NVIDIA nForce all in one Drivers for winME package version 2.64 and 3.62 audio driver.
-2000	-NVIDIA nForce all in one Drivers for 2000 WHQLed package version
-XP	-NVIDIA nForce all in one Drivers for XP WHQLed package version 2.
-Linux	-NVIDIA nForce all in one Drivers for RedHat7.3/RedHat7.3(Kernel 2.6.9) /RedHat8.0 up/SUSE 8.0.
-NT4	-NVIDIA nForce all in one Drivers for NT version 3.4.
-Ntware	-NVIDIA nForce all in one Drivers for Ntware version 2.73.
-DOS	-NVIDIA DOS NDIS Ethernet Driver.
-NVswap	-NVIDIA NVSwap 1.0.
-nvidiaASU	-NVIDIA System utility 0.08.09
--Display	
-2K_XP	-NVIDIA Display Driver.
-98_ME	-NVIDIA Display Driver version 41.13 for windows 2000/XP.
-NT4	-NVIDIA Display Driver version 2.03 WHQL for Windows 98/ME.
	-NVIDIA Display Driver version 43.45 for windows NT 4.0.
--LAN	
-Marvell	-Marvell LAN Driver v6.24.0.0.

## 5.3 NVIDIA® nForce control panel

The NVIDIA® nForce Control Panel is a suite of five convenient applications to help you get the most from all your computer controlled audio systems.

Follow the installation wizard to install the **NVIDIA nForce drivers** from the motherboard support CD.



Use 4-channel or 6-channel speakers for this setup.

### 5.3.1 Launching the NVIDIA® control panel



After installation, the NVIDIA® nForce™ APU icon appears on the bottom right of the Windows desktop.

To launch the NVIDIA control panel, click the NVIDIA nForce APU icon to display the NVIDIA control panel.



### 5.3.2 Main

The **Main** tab includes the primary sliders for adjusting the volume of all sound sources, recording input levels, equalization settings (and presets), as well as a signal meter to visually verify that sound is being produced.

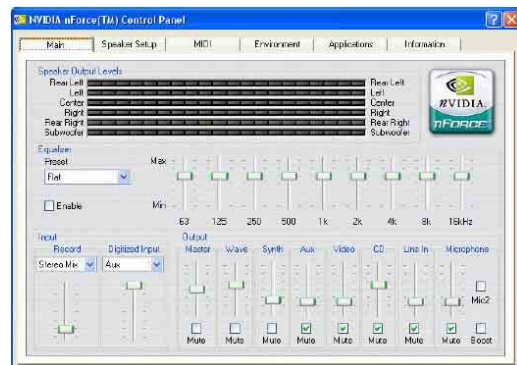

### 5.3.3 Speaker Setup

Click the **Speaker Setup** tab to configure and setup your hardware. This page helps you identify how the speakers are connected to the audio device, and the format to use when sending audio signals out of the PC. Here the number of speakers can be applied, the type of connection (digital or analog), individual volume levels for each speaker (balancing), and a host of specialty features. A wizard is also available to help guide you through the process.

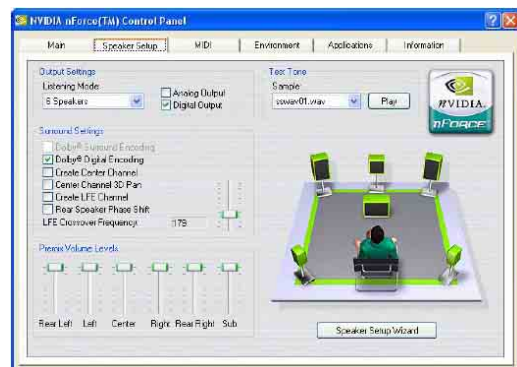

Here are some of the features on the Speaker Setup:

- **Dolby® Surround Encoding** - enables audio to be encoded for playback on home theater receivers (using analog stereo outputs only)
- **Dolby® Digital Encoding** - enables audio to be encoded for playback on 5.1 home theater receivers (using digital SPDIF output only)

This optional S/PDIF audio module allows digital instead of analog sound input and output.

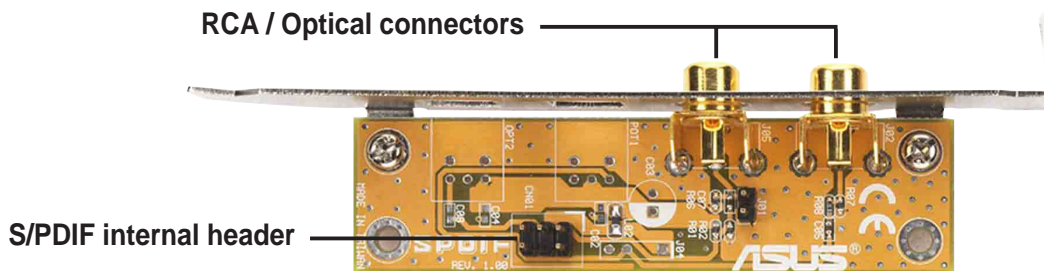

---

For S/PDIF out function, you may use either the module or the S/PDIF connector at the back panel, but not both.

---

- **Create Center Channel** - Generates a center channel for audio content that does not have it natively (like MP3s, WMAS, etc.)
- **Create Channel 3D Pan** - Allows game sounds to be panned through the center speaker when they pass between the left and right speakers (only works for DirectSound3D games)
- **Create LFE Channel** - Generates a subwoofer signal for speaker systems that require it (like Dolby Digital receivers or home theaters with discreet subwoofer inputs)
- **Rear Speaker Phase Shift** - Adjusts the output of the rear speakers so that sounds don't 'cancel out' and remove the bass channel or cause a 'tinny' sound (primarily older 4 channel PC speaker systems)
- **LFE Crossover Frequency** - Adjusts the amount of bass signal removed from the main speakers and sent specifically to the subwoofer output (increment in hertz).

## 5.3.4 MIDI

This tab allows you to change settings to MIDI playback. A MIDI song can be tested at the **Audition** section using all available effects or just the highted effect. The **Download Sounds** section allows the loading and unloading of DLS or SoundFont sample banks from system memory. These banks provide the instrument sounds for any MIDI files played on the system. Finally, at the bottom we have the effects panel. Since this panel is very similar to the Environment tab.

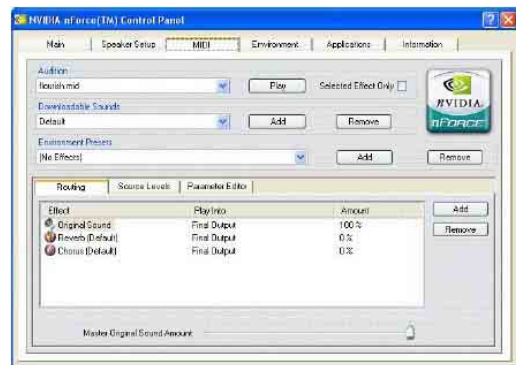

## 5.3.5 Environment

The **Environment** tab is the most powerful section of the application. Like the **MIDI** page, a song or WAV file can be tested, and an environment can be applied using a preset at the **Environment Presets** drop down box. The power comes in the next section where you have the ability to add or remove effects to construct and environment of our own liking.

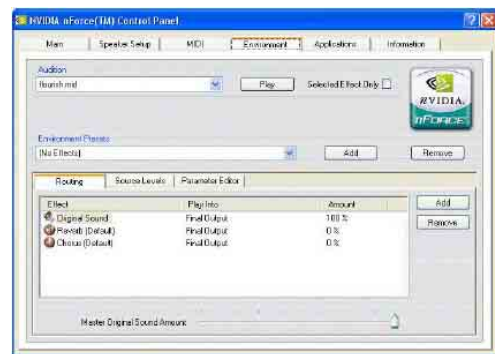

## 5.3.6 Applications

The **Applications** tab is used to put audio application shortcuts. It is just a quick way to get at their favorite audio applications from within the Control Panel. Applications can be added or removed by using the buttons in the lower right hand corner of this page.



## 5.3.7 Information

The **Information** tab shows the details of the APU (optional), hardware and software revisions, driver revisions, current DirectX version, and in “Advanced” mode the DSP and voice utilization. This is the first place to look when you are verifying what drivers you are running and the last place to look when you want to know what is going on at the lower levels of the APU.





## 5.4 NVIDIA® NVSwap 1.0 Utility

### Running the NVSwap Application

NVSwap 1.0 sets up and optimizes your audio experience when you use NVIDIA® audio products such as the NVIDIA SoundStorm™ audio solution. This software helps you configure your speaker setup on NVIDIA nForce™ motherboards equipped with an audio processing unit (APU) or a standard soft audio.

NVSwap is a self-contained application that requires no installation in order to function. To use NVSwap, execute the application found in “\Drivers\All-in-one\nvswap” of the motherboard support CD. You will see a dialogue box similar to the following:

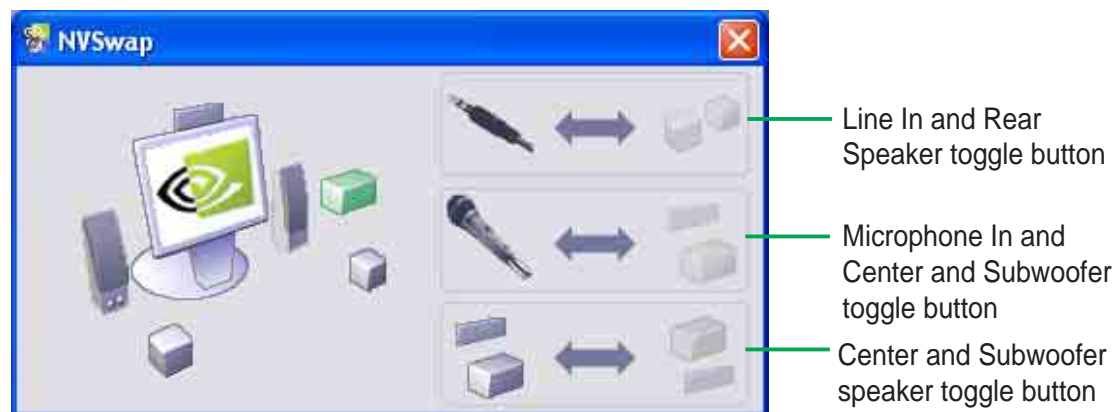

### Testing the Speakers

Immediately after you run the application, the application begins cycling through the speakers with white noise. You see a visual indication of where audio should be coming from. If you do not hear audio coming from the highlighted speaker, check the connections between the sound jacks at the rear of your PC and your speaker system.

If you want to test a specific speaker, left-click on the appropriate speaker icon. This action causes white noise to play on the selected speaker for up to 5 seconds before returning to the cycling pattern.



---

For 6.1 audio channel setting, there is no need to perform the following tasks. Simply connect the Rear Speaker to the purple jack and the Center/Subwoofer to the orange jack.

---

## Line In and Rear Speaker Toggle Button

The first button is for toggling between Line In and Rear Speaker settings. The default setting for the NVSwap application is for Line In to be active. If you are clicking this button, you disable the Line In and enable Rear Speakers.



---

When Rear Speaker is enabled, the connection on your motherboard will not accept a Line In source. Changing this setting has the same effect as selecting or deselecting the “Rear Speakers connected to Line In” option in the Windows Volume Control.

---

## Microphone In and Center and Subwoofer Speaker Toggle button

The second button is for toggling between Microphone In and Center and Subwoofer Speaker settings. The default setting for the NVSwap application is for Microphone In to be active. Clicking this button will disable Microphone In and enable Center and Subwoofer Speakers.



---

When Center and Subwoofer Speaker is enabled, the connection on your motherboard will not accept a microphone. Changing this setting has the same effect as selecting or deselecting the “Center Speaker and Subwoofer connected to Microphone” option in the Windows Volume Control.

---

## Center and Subwoofer Toggle button

The third button is for toggling the mapping between Center and Subwoofer Speakers. This lets you swap the signal going to both speakers, enabling a “virtual rewire” of the speaker jack.



---

Use this option only if you hear sound coming from the subwoofer when the center speaker is highlighted, and vice versa.

---

## 5.5 RAID 0/RAID 1 Configurations

The motherboard includes the Silicon Image Sil 3112A controller chipset and two Serial ATA interfaces to support Redundant Array of Independent Disks (RAID) configuration. This feature supports Serial ATA hard disks. Use the SATAraid™ utility to configure the RAID sets.

RAID 0 (called *data striping*) optimizes two identical hard disk drives to read and write data in parallel, interleaved stacks. Two hard disks perform the same work as a single drive but at a sustained data transfer rate, double that of a single disk alone, thus improving data access and storage.

RAID 1 (called *data mirroring*) copies and maintains an identical image of data from one drive to a second drive. If one drive fails, the disk array management software directs all applications to the surviving drive as it contains a complete copy of the data in the other drive. This RAID configuration provides data protection and increases fault tolerance to the entire system.



---

For more information about the Silicon Image Sil 3112A SATA RAID controller, refer to the Silicon Image SATA RAID User's Manual found in "\Drivers\SATA\SATAraid\_Manual\_Rev092.PDF" of the motherboard support CD.

---

### 5.5.1 Install the hard disks

The Sil 3112A chipset supports Serial ATA hard disk drives. For optimal performance, install identical drives of the same model and capacity when creating RAID sets.

- If you are creating a **RAID 0 (striping)** array for performance, use two new drives.
- If you are creating a **RAID 1 (mirroring)** array for protection, you can use two new drives or use an existing drive and a new drive (the new drive must be of the same size or larger than the existing drive). If you use two drives with different sizes, the smaller capacity hard disk will be the base storage size. For example, hard disk A with an 80 GB storage capacity and hard disk B with 60 GB storage capacity, the maximum storage capacity for your RAID 1 set will be 60 GB.

Follow these steps to install the hard disks for RAID configuration.

1. Install the Serial ATA hard disks into the drive bays.
2. Connect one Serial ATA HDD to each Serial ATA connector, using separate serial ATA cables.
4. Connect the power cable to the power connector on each drive.
5. Make sure that the Serial ATA jumpers are set to enabled. See “2.7 Jumpers, Serial ATA Setting (3-pin SATA\_EN1)” for more detailed information on jumper settings.
6. Proceed to 5.9.2 for the next procedure.

## 5.5.2 Creating and Deleting RAID sets

Creating and deleting RAID sets is a built-in function found in the BIOS. The following sub-sections describes how to use the RAID Configuration Utility.

### Loading the RAID Configuration Utility

During POST, press **<CTRL+S>** or **F4** to enter RAID configuration utility. The following menu options will appear.

```
Create RAID Set
Delete RAID Set
Rebuild RAID Set
Resolve Conflicts
```

Below this menu items are the listed drives installed on the system. The top right half of the screen displays the directions and comments for the user. The bottom right half lists the command keys.

```
↑↓          Select Menu
ESC        Previous Menu
Enter      Select
Ctrl-E     Exit
```

## Creating RAID Sets

1. Select “Create RAID Set”
2. Choose either a “Striped” or “Mirrored” RAID Set.
3. Select if you want the utility to Auto Configure the RAID Set or if you want to manually configure the RAID set. For Striped Sets, you can change the chunk size. For Mirrored Sets, you assign which is the Source and Target drives, as well as if you want a Disk Copy.



- 
- *What is a chunk?* The chunk size is the “stripe” on each disk. It is the unit of storage equivalent to one stripe on a RAID 0 set. Available chunk sizes: [2] [4] [8] [16] [32] [64] [128]
  - When manually setting the chunk size for your RAID set, it is recommended to use the smaller chunk size for server applications and the larger chunk size for AV applications.
  - *What is Disk Copy?* If the disk assigned as the source disk has been partitioned and has data stored on it, and a second disk is added, the data on the source drive can be copied to the destination drive, so the disks are identical, and all subsequent data will be written to both drives as a Mirrored set. If, however, the source disk does not have data stored on it, there is no need for Disk Copy.
- 

4. The utility will ask “Are You Sure? (Y/N)” before completing the configuration. Press “Y” to confirm or “N” to go back to the configuration options.

## Deleting RAID Sets

1. To remove one or more RAID sets, select “**Delete RAID Set**”
2. Select desired set and press “Y” when asked “Are You Sure? (Y/N)”

## Resolving Conflict

When a RAID set is created, the metadata written to the disk includes drive connection information (Primary Chanel, Secondary Chanel). If, after a disk failure, the replacement disk was previously part of a RAID set (or used in another system), it may have conflicting metadata, specifically in reference to the drive connection information. If so, this will prohibit the RAID set from being either created or rebuilt. In order for the RAID set to function properly, this old metadata must be first overwritten with the new metadata. To resolve this, select “**Resolve Conflict**” and the correct metadata, including the correct drive connection information, will be written to the replacement disk.

## 5.6 Onboard Marvell Gigabit LAN drivers for Windows 98SE/ME



---

Before you can use the onboard Gigabit LAN under Windows® 98SE or Windows® ME operating systems, you need to install the onboard LAN drivers from the support CD.

---

### Installing onboard LAN drivers

Follow these instructions to install the onboard LAN drivers for Windows 98SE/ME.

1. Boot your computer.
2. Click the **Start** button. Select **Settings**, then **Control Panel**.
3. Double-click the **System** icon in the Control Panel. Select the **Device Manager** tab.
4. Double-click on **Other devices**.
5. Select **PCI Ethernet controller** with the “?” mark, then click on **Properties**.
6. From the Properties dialog box, select the **Driver** tab then click on **Update Driver**.
7. Click **Next** on the succeeding screen.
8. Select the **Display a list of all the drivers in a specific location, so you can select the driver you want** option, then click **Next**.
9. From the Select Device dialog box, click **Have Disk...**
10. From the Install From Disk dialog box, click **Browse...**
11. Select the LAN driver for your Windows® 98SE/ME OS from following path of the motherboard support CD:

**\\Drivers\LAN\Marvell\Windows\Win9xME**

click **OK**.

12. Follow the succeeding screen instructions.
13. When prompted, remove the support CD and insert the Windows 98SE or Windows ME support CD, then click **OK**.
14. Follow the succeeding screen instructions to complete installation.
15. When prompted to restart your computer, click **Yes**.

## 5.7 Marvell® Virtual Cable Tester™ (VCT) Technology

The motherboard supports the Marvell® Virtual Cable Tester (VCT) Technology. The VCT virtually diagnose and report cable faults using the Time Domain Reflectometry (TDR). With this essential tool, installation and network diagnosis has never been easier. The VCT technology detects and reports open and shorted cables with up to 1 meter of accuracy. It also detects impedance mismatches, pair swaps, pair polarity problems and pair skew problems of up to 64ns.

VCT remarkably reduces networking and support costs complementing a highly manageable and controlled network system. Also, this tool can be incorporated in the network systems software making it ideal for field support as well as development diagnostics.

### Using the Virtual Cable Tester™

To use the the Marvell® Virtual Cable Tester™ on your computer.

1. Click the **Start** button. Select **All Programs -> Marvell -> Virtual Cable Tester**.
2. From the menu, click **Virtual Cable Tester**. The following screen display appears.

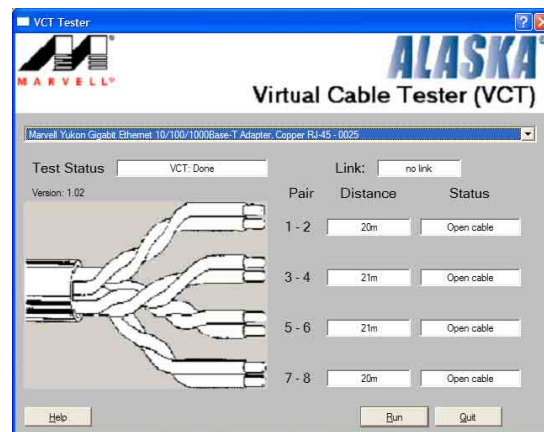

3. Click on **Run** to execute test.



- The Virtual Cable Tester™ (VCT) feature is supported in Windows® XP™ and Windows® 2000™ operating systems only.
- The Virtual Cable Tester™ (VCT) feature works in Gigabit LAN only.
- The **Run** button on the VCT Tester dialogue box is disabled if no problem is detected on the network.

